



VX-601

User's Manual



Contents

CONTENTS	3
SAFETY PRECAUTIONS	6
REGULATORY AND CERTIFICATION	8
FCC	8
CE MARKING	9
RED	9
LITHIUM BATTERY SAFETY STATEMENT	9
CHAPTER 1. PRODUCT INTRODUCTION	10
HARDWARE SPECIFICATIONS	10
ENVIRONMENT	11
I/O PORTS	12
DIMENSION AND WEIGHT	13
VX-601 STANDARD	13
VX-601 WITH I/O WATER-PROOF BOX	14
PACKAGE LIST	15
CHAPTER 2. HARDWARE INSTALLATION	17
M.2 MODULE	17
INSTALLING/REMOVING A M.2 MODULE	17
ACCESSING THE SD CARD	19
INSTALLING/REMOVING THE SIM CARD	21
INTERNAL SIM SLOT	21
INSTALLING/REMOVING THE WWAN MODULE	22
INSTALLING WWAN ANTENNAS	23
EXTERNAL ANTENNAS	23
INSTALLING WLAN ANTENNAS	24
EXTERNAL ANTENNAS	24
INSTALLING/REMOVING ANTENNA BOX	25
CHAPTER 3. HARDWARE MOUNTING	26
INSTALLING U-SHAPE MOUNT	26

CHAPTER 4. START UP	29
POWERING THE SYSTEM	29
CONNECTOR POWER.....	30
POWER SOURCE FROM CAR POWER CABLE.....	30
POWER SOURCE FROM EXTERNAL POWER ADAPTER.....	31
POWER ON THE SYSTEM.....	31
LED STATUS.....	32
ADJUST THE SPEAKER VOLUME	34
AUTO-BRIGHTNESS ADJUSTMENT	34
MANUAL BRIGHTNESS ADJUSTMENT	35
INTERNAL MICROPHONE	35
DISPLAY ON/OFF	35
DEFROST ON/OFF (ONLY AVAILABLE UPON REQUEST)	35
PROGRAMMABLE BUTTONS.....	36
POWER MANAGEMENT.....	36
CHAPTER 5. JUMPERS AND CONNECTORS	37
BOTTOM VIEW	37
EXTERNAL CONNECTORS PIN ASSIGNMENTS	38
POWER CONNECTOR	38
RS-232 PORT (COM1)	39
RS-232/422/485 PORT (COM2)	40
DIGITAL I/O, CANBUS AND DR PORT.....	41
VIDEO PORT	42
CHAPTER 6. KEY MAPPING	43
CHAPTER 7. DASHON SETTING	44
DEVICE INFORMATION.....	45
VEHICLE STATUS	46
COMMUNICATION SETTING	47
ENABLE/ DISABLE MODULE.....	47
WWAN COMMUNICATION SETTING	48
SYSTEM STATUS & SETTING	49
POWER MANAGEMENT SETUP	49
WAKE UP SETTING.....	54
I/O CONFIGURATION	56

BRIGHTNESS SETTING	57
WATCHDOG TIMER	58
PROGRAMMABLE BUTTON	60
LOCATION AND SENSOR.....	63
ENABLE/ DISABLE GPS RECEIVER	65
SERIAL PORT SETTING	66
BAUD RATE SETTING	66
CHAPTER 8. MAIN BIOS SETTING.....	67
SET BOOT SEQUENCE.....	67
SET THE SYSTEM CONFIGURATION	68
SETTING THE SYSTEM DATE	68
SETTING THE SYSTEM TIME	68
SYSTEM INFORMATION.....	69
BOOT FEATURES	69
MISCELLANEOUS CONFIGURATION.....	70
ACCOUNT'S PASSWORD SETTING.....	70
HDD SECURITY SETTING.....	71
CHAPTER 9. WI-FI HOTSPOT SETUP	72

Safety Precautions

1. Read these safety instructions carefully.
2. Keep this user's manual for later reference.
3. Disconnect this equipment from any AC outlet before cleaning. Use a damp cloth. Do not use liquid or spray detergents for cleaning.
4. For plug-in equipment, the power outlet socket must be located near the equipment and must be easily accessible.
5. Keep this equipment away from humidity.
6. Put this equipment on a stable surface during installation. Dropping it or letting it fall may cause damage.
7. Do not leave this equipment in either an unconditioned environment or in an above 40°C storage temperature as this may damage the equipment.
8. The openings on the enclosure are for air convection to protect the equipment from overheating. **DO NOT COVER THE OPENINGS.**
9. Make sure the voltage of the power source is correct before connecting the equipment to the power outlet.
10. Place the power cord in a way so that people will not step on it. Do not place anything on top of the power cord. Use a power cord that has been approved for use with the product and that it matches the voltage and current marked on the product's electrical range label. The voltage and current rating of the cord must be greater than the voltage and current rating marked on the product.
11. All cautions and warnings on the equipment should be noted.
12. If the equipment is not used for a long time, disconnect it from the power source to avoid damage by transient overvoltage.
13. Never pour any liquid into an opening. This may cause fire or electrical shock.
14. Never open the equipment. For safety reasons, the equipment should be opened only by qualified service personnel.
15. If one of the following situations arise, get the equipment checked by service personnel:
 - a. The power cord or plug is damaged.
 - b. Liquid has penetrated into the equipment.
 - c. The equipment has been exposed to moisture.
 - d. The equipment does not work well, or you cannot get it to work according to the

user's manual.

- e. The equipment has been dropped and damaged.
- f. The equipment has obvious signs of breakage.

16. Do not place heavy objects on the equipment.
17. The unit uses a three-wire ground cable which is equipped with a third pin to ground the unit and prevent electric shock. Do not defeat the purpose of this pin. If your outlet does not support this kind of plug, contact your electrician to replace your obsolete outlet.
18. **CAUTION:** DANGER OF EXPLOSION IF BATTERY IS INCORRECTLY REPLACED. REPLACE ONLY WITH THE SAME OR EQUIVALENT TYPE RECOMMENDED BY THE MANUFACTURER. DISCARD USED BATTERIES ACCORDING TO THE MANUFACTURER'S INSTRUCTIONS.
19. Continuously displaying a fixed pattern may induce image sticking. It's recommended to use screen saver or shuffle content periodically when a fixed pattern is displayed on the screen.

Regulatory and Certification

FCC

This device complies with Part 15 of the FCC Rules. Operation is subject to the following two conditions:

1. This device may not cause harmful interference.
2. This device must accept any interference received, including interference that may cause undesired operation.

This equipment has been tested and found to comply with the limits for a Class B digital device, pursuant to Part 15 of the FCC Rules. These limits are designed to provide reasonable protection against harmful interference in a residential installation. This equipment generates, uses, and can radiate radio frequency energy and, if not installed and used in accordance with the instructions, may cause harmful interference to radio communications. However, there is no guarantee that interference will not occur in a particular installation. If this equipment does cause harmful interference to radio or television reception, which can be determined by turning the equipment off and on, the user is encouraged to try to correct the interference by one or more of the following measures:

- Reorient or relocate the receiving antenna.
- Increase the separation between the equipment and the receiver.
- Connect the equipment into an outlet on a circuit different from that to which the receiver is connected.
- Consult the dealer or an experienced radio/TV technician for help.

Shielded interconnect cables and shielded AC power cable must be employed with this equipment to insure compliance with the pertinent RF emission limits governing this device. Changes or modifications not expressly approved by the system's manufacturer could void the user's authority to operate the equipment.



Any changes or modifications not expressly approved by the party responsible for compliance could void the user's authority to operate the equipment.

This device is operable in 5.15 – 5.25GHz frequency range, then restricted in indoor use only, Outdoor operations in the 5.15 – 5.25GHz is prohibitive.

CE Marking

This product has passed the CE test for environmental specifications when shielded cables are used for external wiring. We recommend the use of shielded cables. Please contact your local representative for ordering information.

This product has passed the CE test for environmental specifications. Test conditions for passing included the equipment being operated within an industrial enclosure. In order to protect the product from being damaged by ESD (Electrostatic Discharge) and EMI leakage, we strongly recommend the use of CE-compliant industrial enclosure products.

RED

This device complies with the essential requirements of the RED.

Lithium Battery Safety Statement

Lithium battery inside. Danger of explosion if battery is incorrectly replaced. Replace only with the same or equivalent type recommended by battery manufacturer.



THIS PRODUCT CONTAINS LITHIUM-ION BATTERY PACKS. IT MUST BE DISPOSED OF PROPERLY. CONTACT LOCAL ENVIRONMENTAL AGENCIES FOR INFORMATION ON RECYCLING AND DISPOSAL PLANS IN YOUR AREA.

Chapter 1. Product Introduction

VX-601 is a 12.4” in-vehicle terminal with 700/1200nits brightness display and is flexible to support a wide range of wireless connection capability. The device is well-suited for warehouse management, harbor management, asset management applications. VX-601’s optimized power system is designed for cold cranking, load dump, transient voltage and ESD. The device is engineered with IP66 protection rating, a wide temperature design, wide input range, and rich expanding interfaces that support in-vehicle connectivity.

Hardware Specifications

Item	Description
Processor	Intel® Core™ i5-6300U 2.4GHz Processor Intel® Celeron® Processor 3955U 2.0GHz Processor
Memory	DDR3L 4GB SODIMM up to 32GB (32GB by request)
Storage	M.2 2280 x 1, SD slot x 1
Display	<ul style="list-style-type: none"> ● 12.1-inch XGA (1024 x 768) ● 700/ 1200 nits ● Viewing angel: 160(H)/ 160(V) (CR>10)
Touch Panel	<ul style="list-style-type: none"> ● Resistive touch screen support optional defrost ● Projected Capacitive Touch Screen (by request)
Wireless Connectivity	<ul style="list-style-type: none"> ● 802.11 a/b/g/n/ac 2x2 ● Bluetooth 4.0 + HS ● GPS / QZSS or GLONASS (COM3, optional) ● 1 mini PCIe slot (full size) for cellular module ● External SMB Jack connectors for wireless expansion (GPS) *support external antenna only ● External RP-SMA Jack connectors for wireless expansion (Wi-Fi/BT/WWAN) *Wi-Fi supports external or internal, the default setting is internal antenna. Support external antenna SMA Jack change. WWAN support external antenna only.

Item	Description
Power Input	9~60VDC, 12A
Battery	4500mAh, 10.8V
Housing (Mechanical)	Die-casting aluminum, fanless design
Certification	CE, FCC, CB

Environment

- Operating temperature:
 - -30°C (-22°F) to 55°C (131°F)
 - In accordance with MIL-STD-810G CHANGE1 Method 501.6 High Temperature Procedure II - Operation
 - In accordance with MIL-STD-810G CHANGE1 Method 502.6 Low Temperature Procedure II – Operation
- Storage temperature:
 - -40°C (-40°F) to 70 °C (158°F)
 - In accordance with MIL-STD-810G CHANGE1 Method 501.6 High Temperature Procedure I – Storage
 - In accordance with MIL-STD-810G CHANGE1 Method 502.6 Low Temperature Procedure I - Storage
- Relative humidity: 5% to 95% @ 30°C (86°F) to 60°C (140°F) non-condensing in accordance with MIL-STD-810G CHANGE1 Method 507.6 Humidity Procedure II Aggravated Cycles (Fig 507.6-7)
- Vibration Test:
 - Operating: MIL-STD-810G CHANGE1 Method 514.7 Category 4, Fig 514.7C-2 Common carrier (US highway truck vibration exposure); Fig 514.7C-3 Composite two-wheeled trailer; Fig 514.7C-4 Composite wheeled vehicle
 - Non-Operating: MIL-STD-810G CHANGE1 Method 514.7 Category 24, Fig 514.7E-1 (General minimum integrity exposure)
- Shock Test:
 - Operation: MIL-STD-810G CHANGE1 Method 516.7 Procedure 1 Functional

Shock

- Non-Operation: MIL-STD-810G CHANGE1 Method 516.7 Procedure V Crash Hazard Shock

I/O Ports

Item	Description
Serial	RS-232 x 1 with 0/5/12V support 0.6A (COM1) RS-232/422/485 x 1 (COM2)
USB	USB 3.0 x 1 USB 2.0 x 1
Ethernet	Gigabit RJ45 x 1
Digital I/O	2 DI and 2 DO
CAN	CANbus (SAE J1939 / OBDI II supported)
Audio	Headset jack x 1 Internal MIC-in x 1
Speaker	Waterproof speakers 3W

Dimension and Weight

VX-601 Standard

Dimension (w/ antenna cover) : 325 x 280 x 69.6mm / 12.80 x 11.04 x 2.74in. (W x H x D)

Dimension (w/o antenna cover) 325 x 262 x 69.6mm/ 12.80 x 10.31 x 2.74in. (W x H x D)

Weight: 4.8 kg/ 10.58 lbs. (with storage)

Front View Dimension

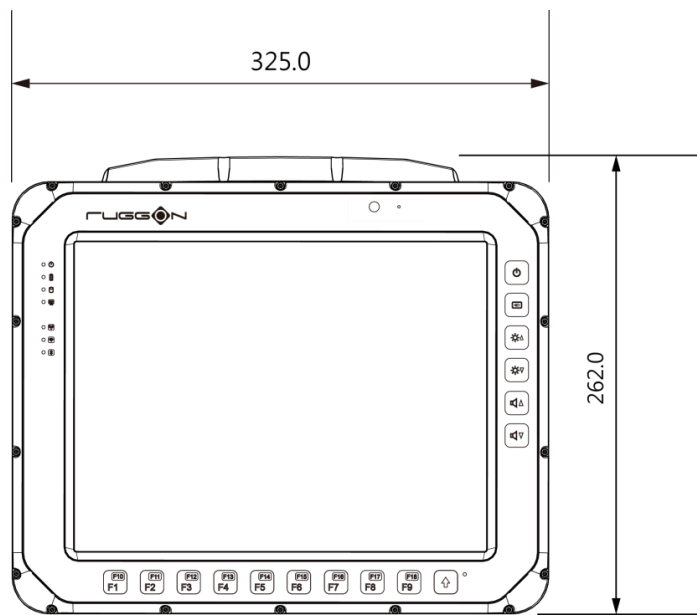

Side View Dimension

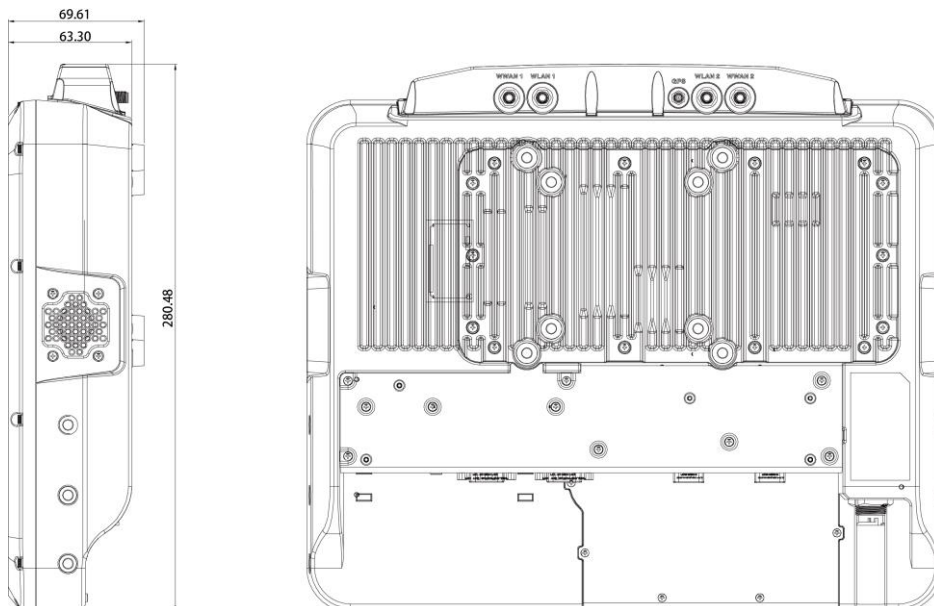

VX-601 with I/O water-proof box

Dimension (w/ antenna cover) : 325 x 280 x 69.6 mm / 12.80 x 11.04 x 2.74in. (W x H x D)

Dimension (w/o antenna cover) : 325 x 262 x 69.6mm/ 12.80 x 10.31 x 2.74in.(W x H x D)

Weight: 4.9 kg / 10.80 lbs. (with storage)

Front View Dimension

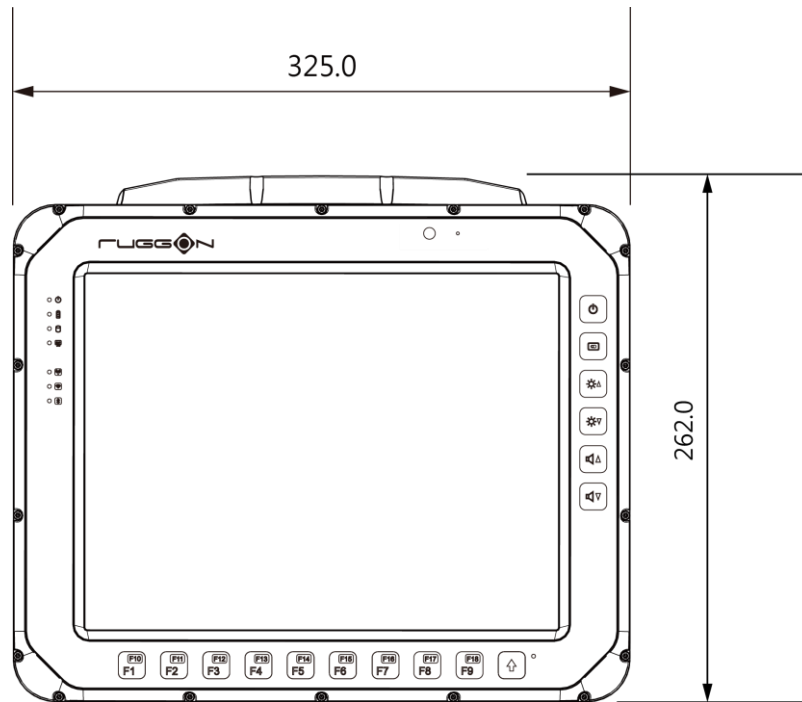

Side View Dimension

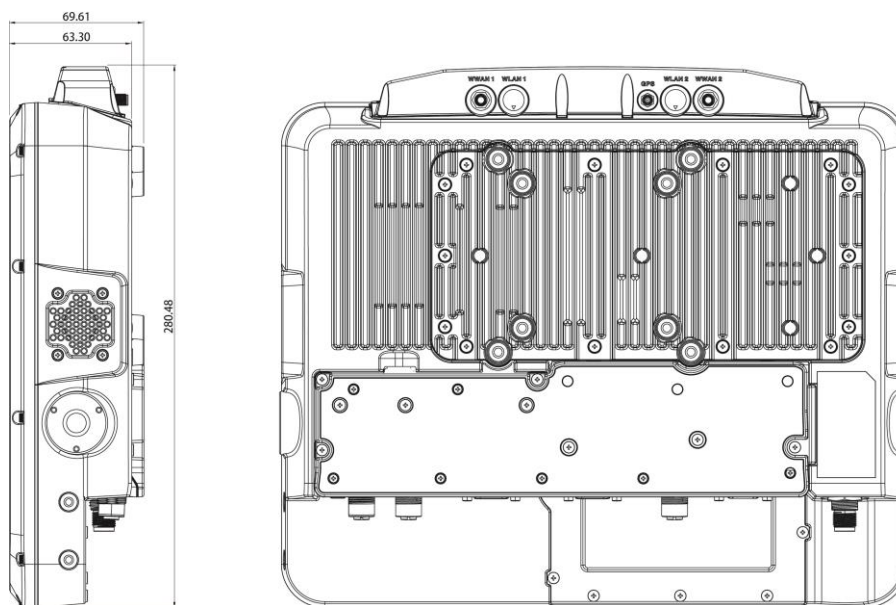

Package List

Before you begin the installation or configuration process, make sure to inspect all the components and accessories. Contact your representative if there are any missing or damaged items.

Please verify the delivery of the contents upon receipt

- VX-601 vehicle mount computer
- Protection film (You can choose to paste it on the screen. See the image below)
- Accessory Box:
 - Bare wire power cable with circular power connector
 - Thermal pad
 - Cable tie

NOTE: The packaging material has been selected to optimally protect your device. After unpacking, store the original packaging material in the event that you need to return for shipment.

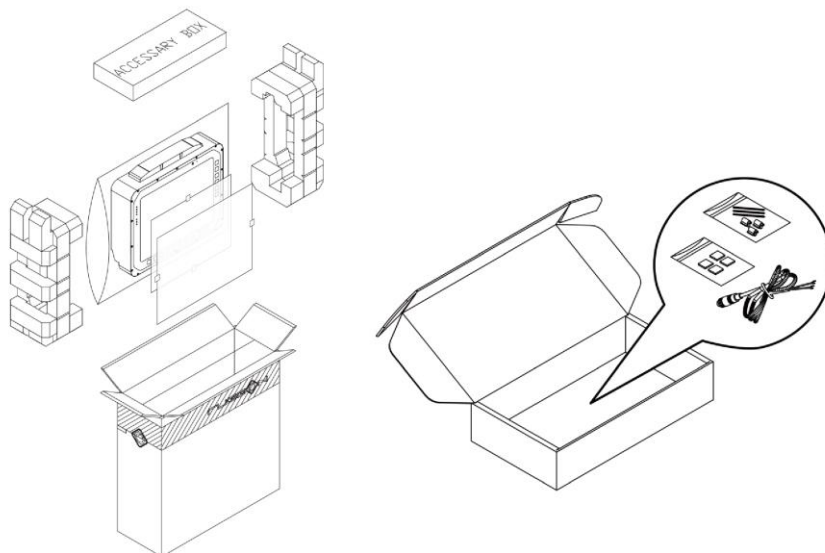

The protection film is placed on the product screen in the package. You can use it to increase touch screen durability and protection from scratching, etching, and damage. Designed with a low-tack adhesive, the protection film is easy to apply and remove. It is also engineered to be touch-sensitive and won't affect touch or swipe functions. You can choose whether you want to paste it onto the touch screen or not.

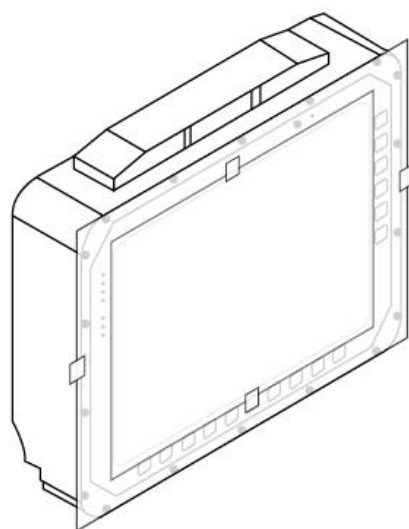
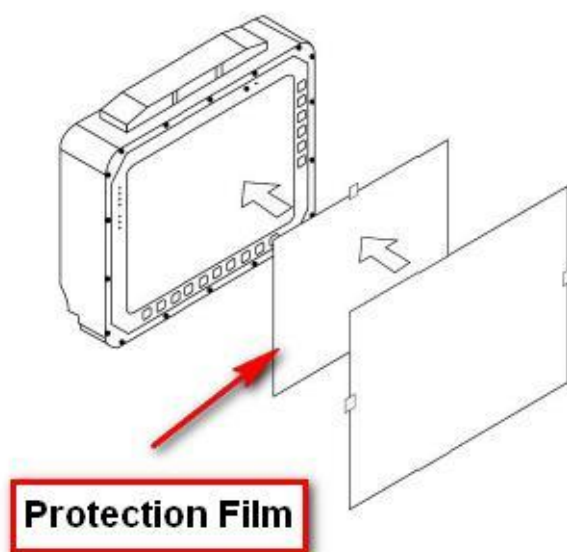

Chapter 2. Hardware Installation

This chapter provides information for the installation and removal of M.2 storage and mini PCIe card.

M.2 Module

Prevention of EMI interference in this device is not guaranteed if the original components are replaced.

A single M.2 2280 module slot is available for memory expansion. The device supports up to 256GB.

Installing/Removing a M.2 Module

1. Shut down the system properly and disconnect the device from all power sources.
2. Un-mount the device from the mounting apparatus; make sure that the display surface is protected.
3. Remove the screws and the service cover.

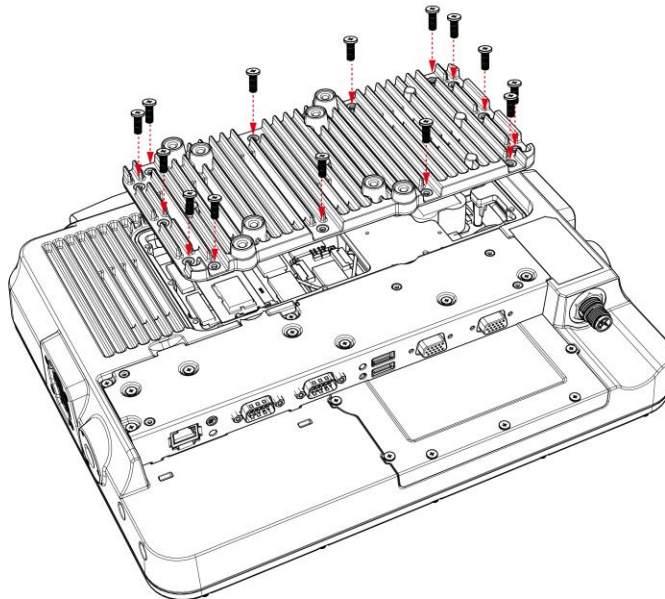

4. Locate the M.2 module slot; see the following image.

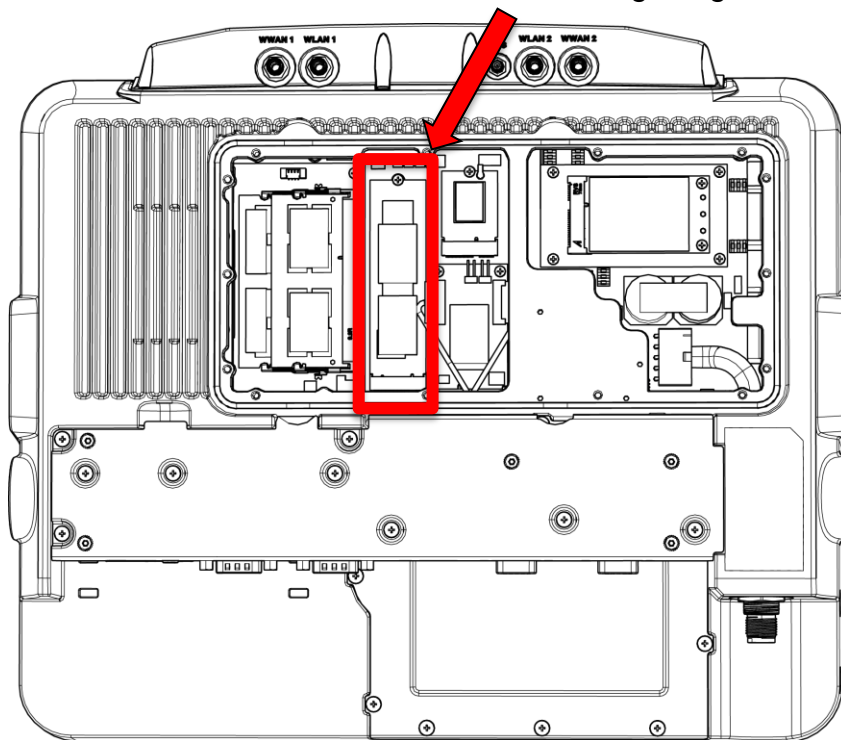

5. Insert the M.2 module into the slot and then fasten the screws or loosen the screws to remove the card
6. Replace the service cover.

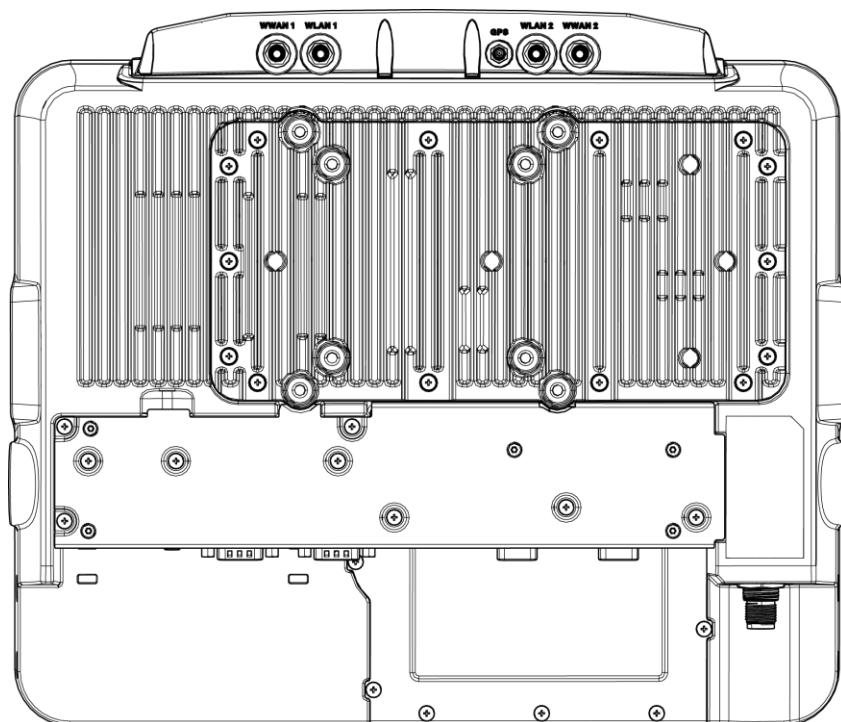

Accessing the SD card

1. Remove the screws to open IO Module.

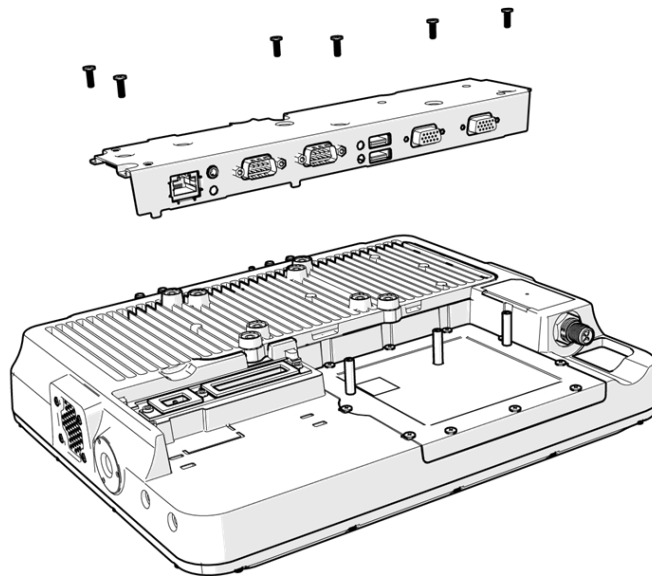

2. Then open the battery door and take out the battery

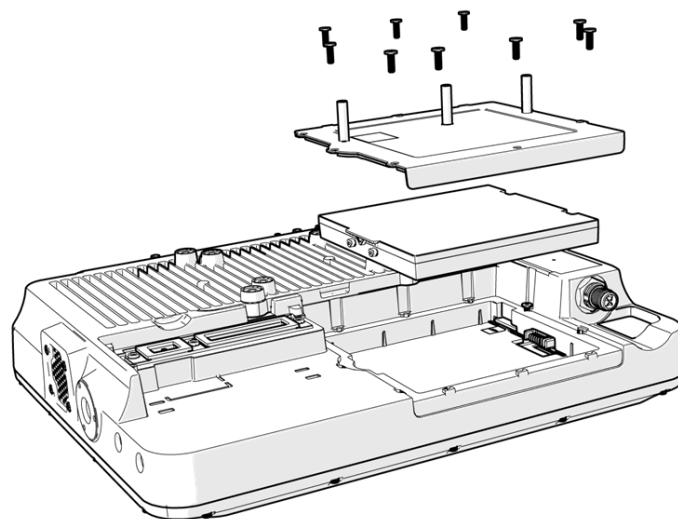

3. Insert the SD card (Please refer to the image below for the placement position)

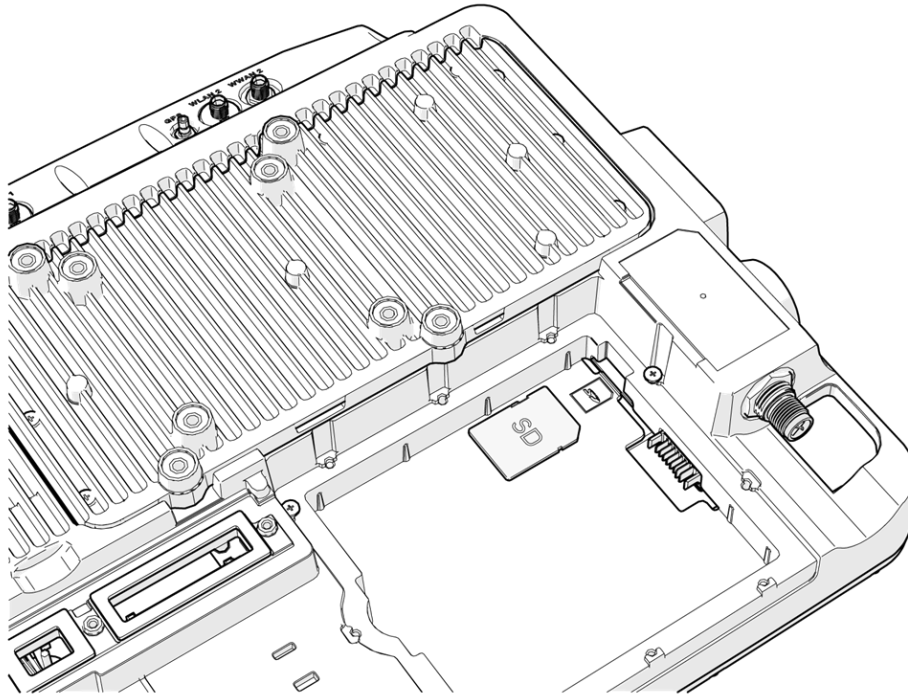

Installing/Removing the SIM card

VX-601 provides dual micro SIM slots which are located inside the service door. Install your SIM card in SIM 1 slot or SIM 2 slot. You can select from the two SIM slots via the SIM slot assignment option in DashON interface. The factory default is SIM 1 slot. Please see the following guidelines to install or remove your SIM card.

Internal SIM slot

1. Shut down the system properly and disconnect the device from all power sources.
2. Un-mount the device from the mounting apparatus; make sure that the display surface is protected.
3. Remove the screws securing the cover and remove the cover.
4. Once the service cover is removed, you can see the micro SIM card slot.

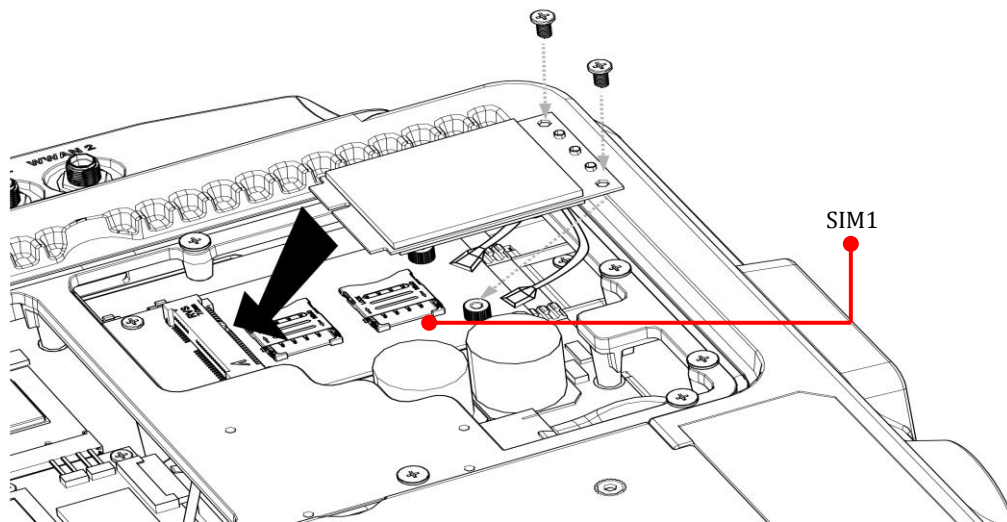

5. Slide to unlock the lock on the locking lid.
6. Lift the locking lid up and insert your SIM card.
7. Lock the locking lid back after insertion.

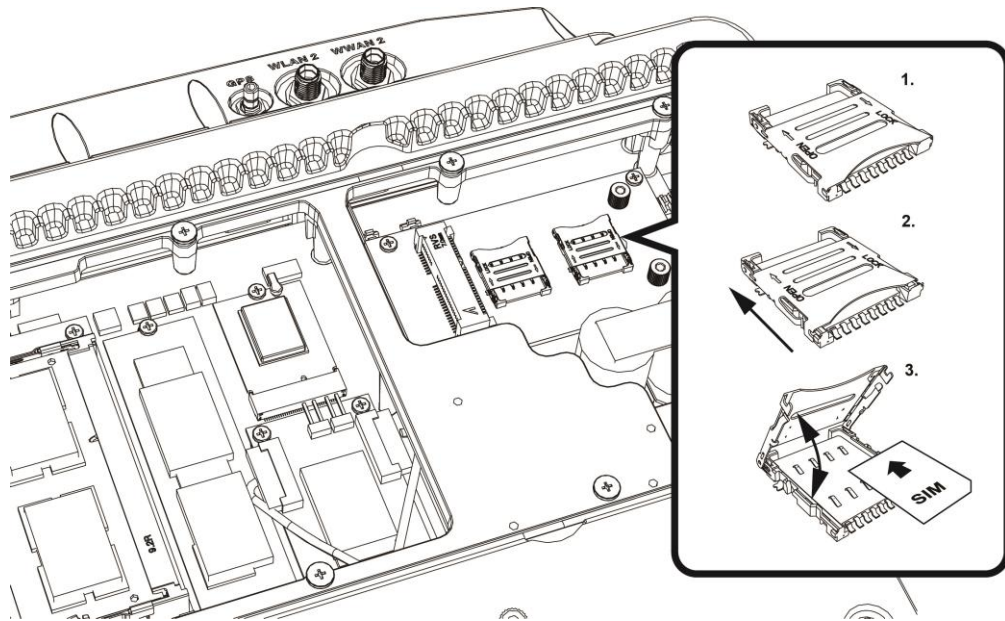

8. Turn your SIM card to the angled corner of your SIM card to match the angled corner of the SIM card holder.
9. Insert the SIM card into the SIM card holder.
10. Close the cover of the SIM card holder.

Installing/Removing the WWAN module

WWAN card slot is also located on the rear side; it is up to the Wi-Fi module. Please read through the following introduction to install or remove the module

1. Power down the device and disconnect it from all power source.
2. Un-mount the device from the mounting apparatus; make sure that the display surface is protected.
3. Open the service cover; locate the WWAN module slot on the VX-601.

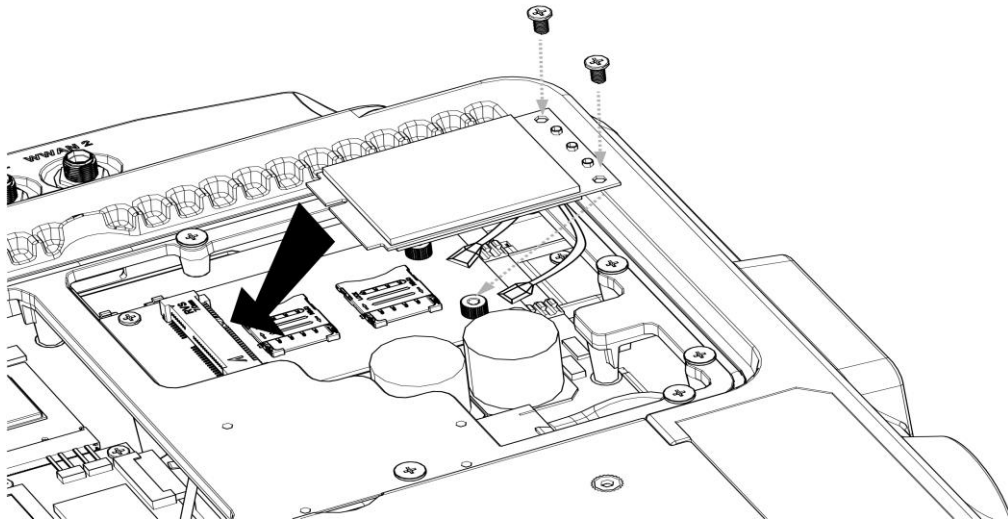

4. Install or remove the module.

Installing WWAN Antennas

After you installed the WWAN module, you need to connect the antenna for use. Please note VX-601 supports internal (optional) or external WWAN antenna. If you would like to use the internal or external WWAN antenna, you need to manually disable either one of them. The following section will guide you through how to change your internal/ external antenna.

External Antennas

1. Locate the antenna cables. (black cable & grey cable)
2. Use the black antenna cable to connect to the connector labeled **MAIN**. Use the grey antenna cable to connect to the connector labeled **AUX**.

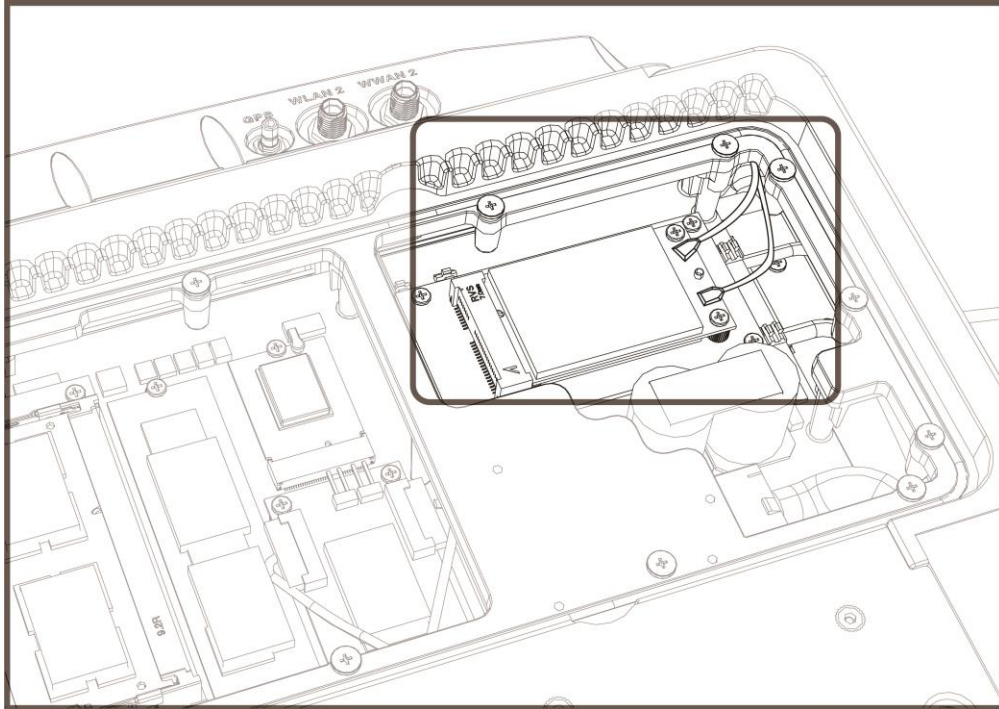

Installing WLAN Antennas

VX-601 supports WLAN internal and external antennas connections, and the default is internal; if you would like to connect WLAN external antenna, please disable the current WWAN antennas. The following section will guide you through how to change your internal/external antenna.

External Antennas

1. WLAN module card is under the WWAN module. Please take out the WWAN module, and you will see the WLAN module.
2. Locate the antenna cables. (black cable & grey cable)
3. Use the black antenna cable to connect to the connector labeled **MAIN**. Use the grey antenna cable to connect to the connector labeled **AUX**.

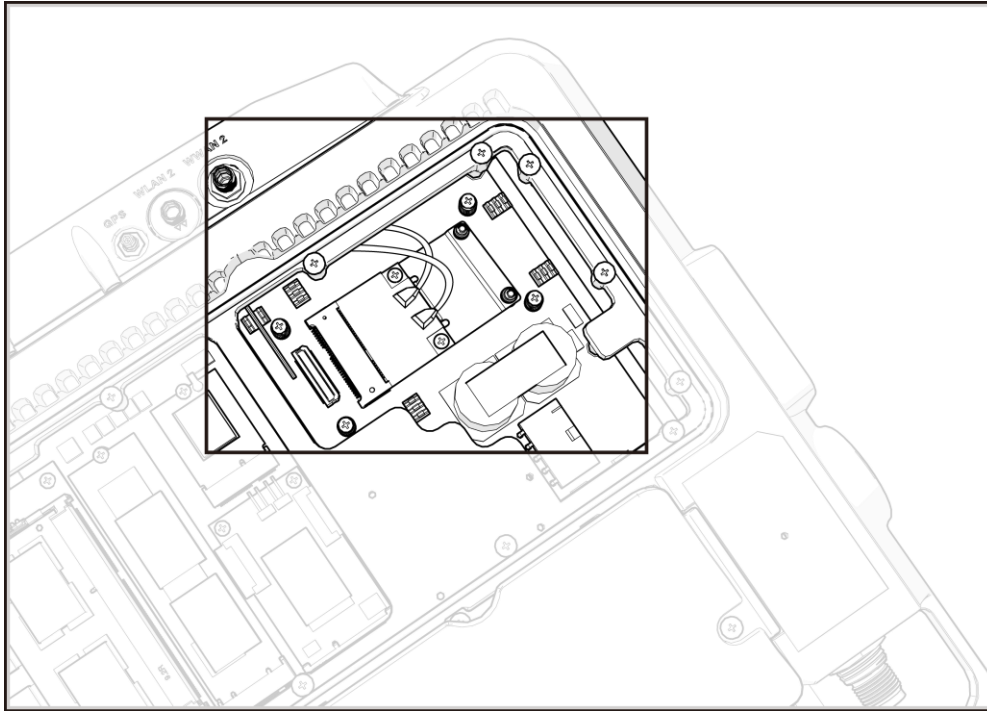

Installing/Removing Antenna Box

VX-601's antenna box can be removed and installed by manually removing the 8 screws located on the side of the antenna box. If you want to manually adjust the WWAN/WLAN antenna cable, please follow the instructions below:

1. Carefully remove the antenna box
(Note: do not pull the antenna box or you may damage the cable).
2. Manually install or remove the antenna cable or SMA to suit your working needs.

Chapter 3. Hardware Mounting

The VX-601 supports a standard VESA version MIS-D, 75/100, C (75/100mm distance quadrate order, M5 thread, depth 10mm) through the four drill holes on the back side of the device.

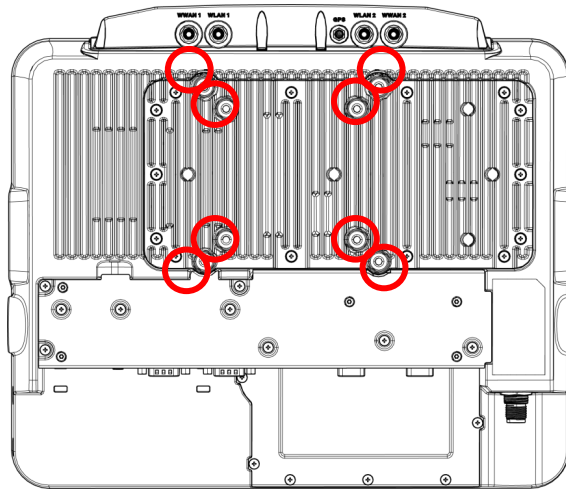

Notes: *To prevent any damage or injury, make sure the mounting bracket is securely attached.*

Installing U-Shape Mount

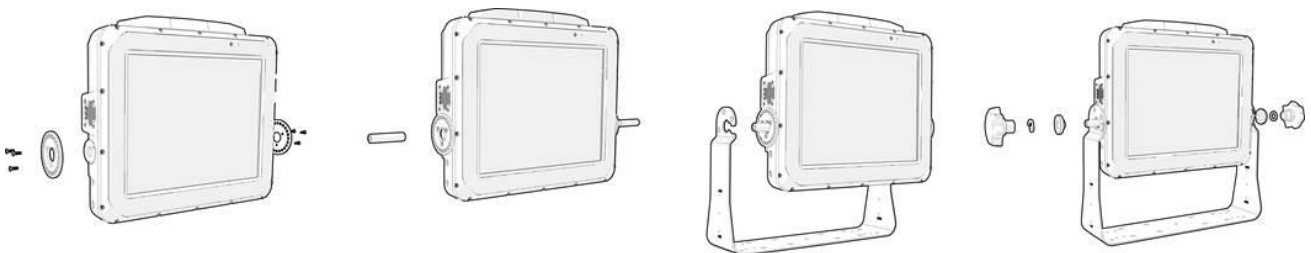

The U-shape mount is provided as an optional purchase. Please follow the steps below to install the U-shape mount.

1. Place the following wheel plates onto VX-601 and lock them with three screws on each side.

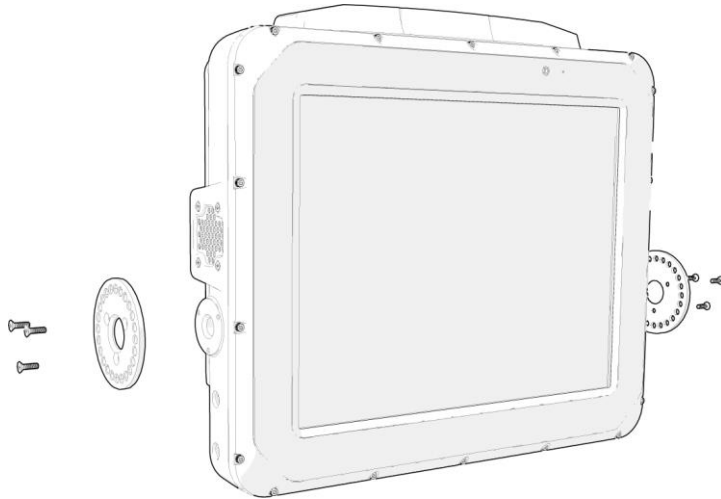

2. Use a hex key and tighten the hex lock into both sides of VX-601 threads.

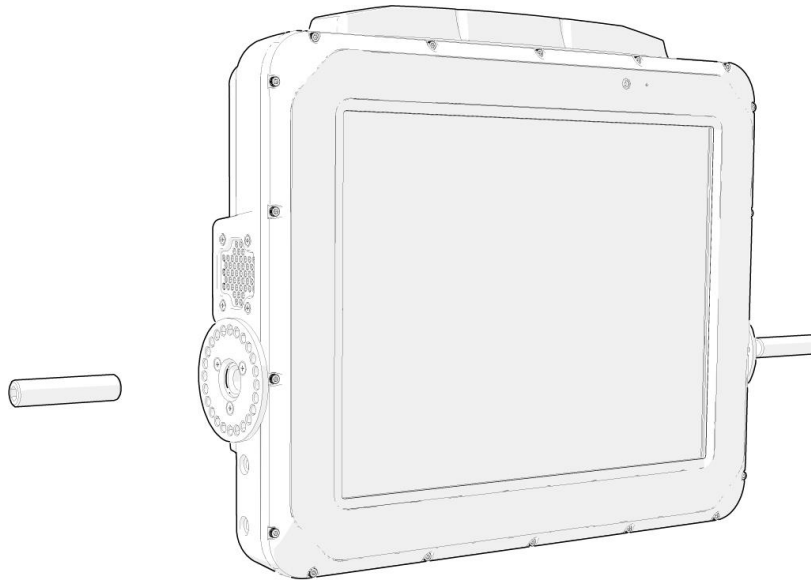

3. Secure the hex lock on the U-shape mount frame using a 6 millimeter hex wrench.

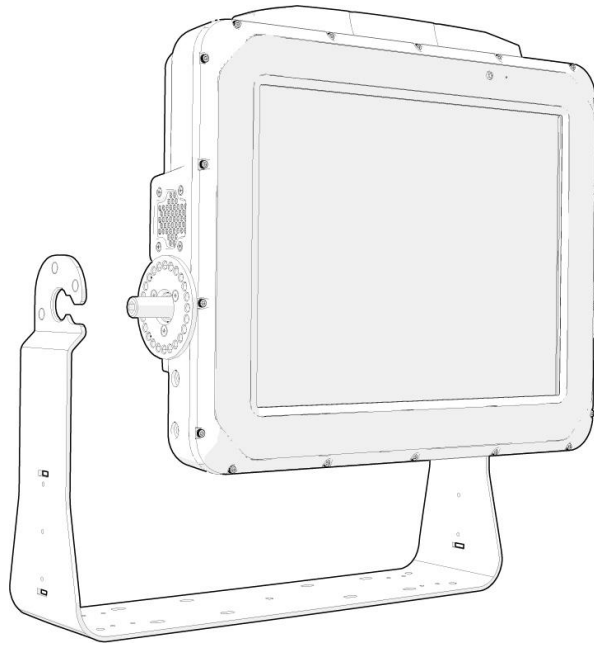

4. Insert the plain washer and spring lock washer, and then tighten knobs on both sides accordingly.
5. To adjust the angles of VX-601, untighten the knobs.

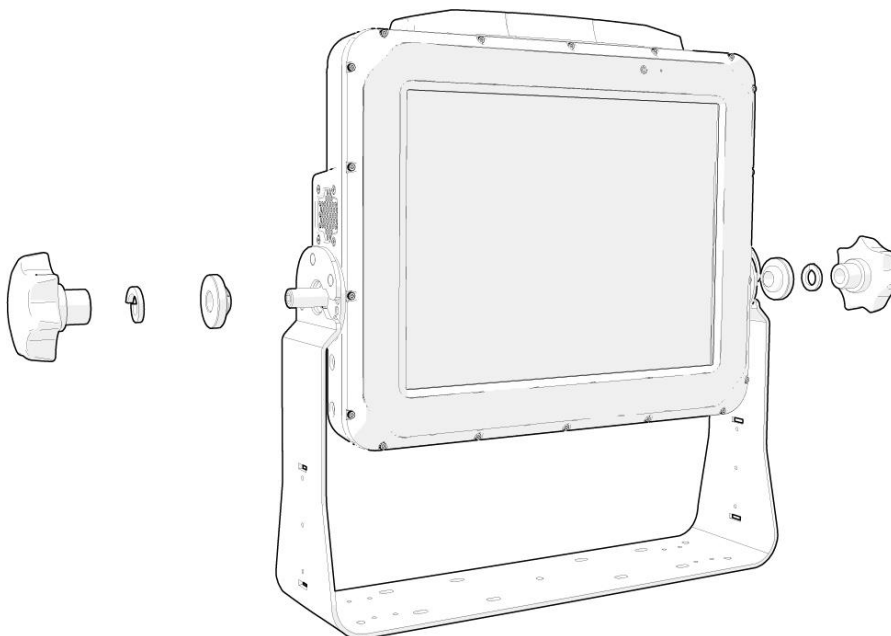

Chapter 4. Start up

Powering the System



Make sure that all the power supplies are disconnected when you plug the power cord into the power connector.

Fuses 15A are required in connecting the power cable and battery in series to avoid the risks of wire damage and vehicle burning.

Please refer to the diagram below for VX-601 installation.

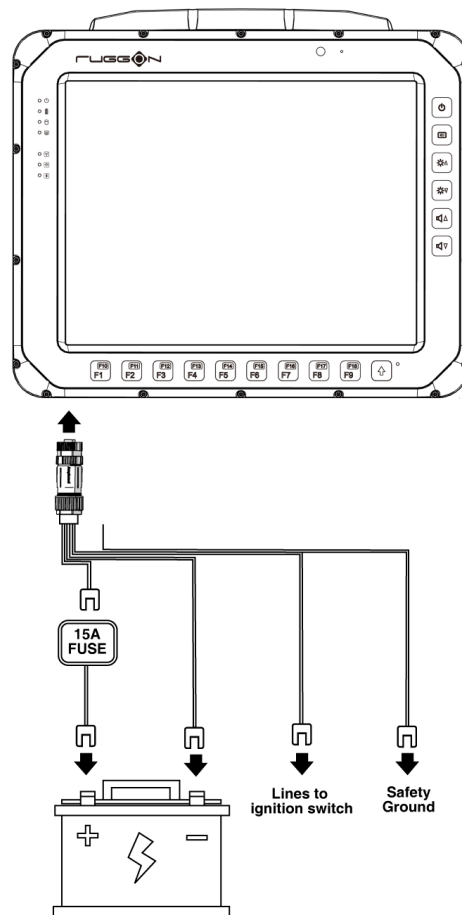

Connector Power

VX-601 allows a wide range of DC power input from 9~60V via a 4-pin circular power cord. There are two options to start up the VX-601 via car power cable or external power adapter. Here is the 4-pin circular power cord.

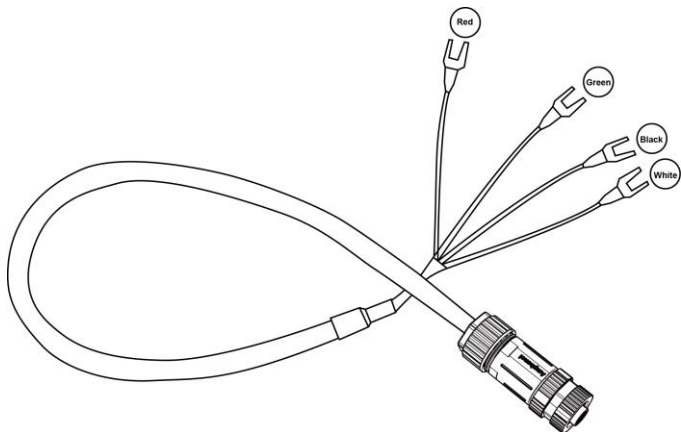

The wire definition.

Wire Color	Description
RED	V+
BLACK	V-
GREEN	Chassis Ground
WHITE	ACC/ Ignition

Power source from car power cable

1. The bare wire lead cable allows you to directly wire 12 V, 24 V, 36V and 48V power cable or adapters. Please follow the wire definition to connect to your power source.
2. Plug the power code into the power connector facing the top of the arrow mark.

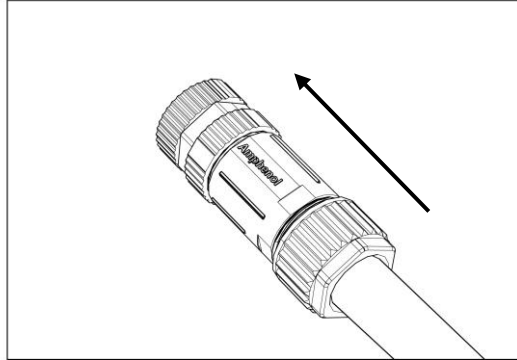

3. Twist the nut to lock the power connector to the device.

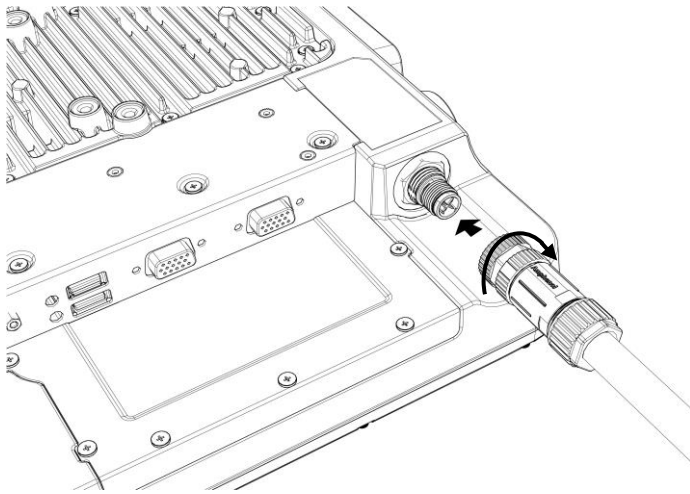

Power source from external power adapter

If your power source is from external power adapter, your power source will not be controlled by AAC/ignition signal. Please short red (V+) and white (ACC/ Ignition) wires.

Power on the System

VX-601 has two power modes for user preference which can be activated through DashON.

If you want to use power source via power adapter, please disable “ACC Input Detection”.

To turn on the system, please follow the directions below:

1. Press power button to turn on the system

2. When VX-601 is in “Non-ACC mode” (*Default is Non-ACC mode), the device will not auto power off when the power supply is removed (charged from UPS battery instead), please use windows command to fully shut down the device.
3. When VX-601 is in “ACC Sense Mode”, please follow the directions below:
 - When the system is off, switch the ignition from off to on, the system will turned on/delay on.
 - When the system is off and the ignition is off, press the power button, the system will be turned on/no delay on.
 - When System is off and the ignition is on, press the power button, the system will be turned on/no delay on.

LED Status

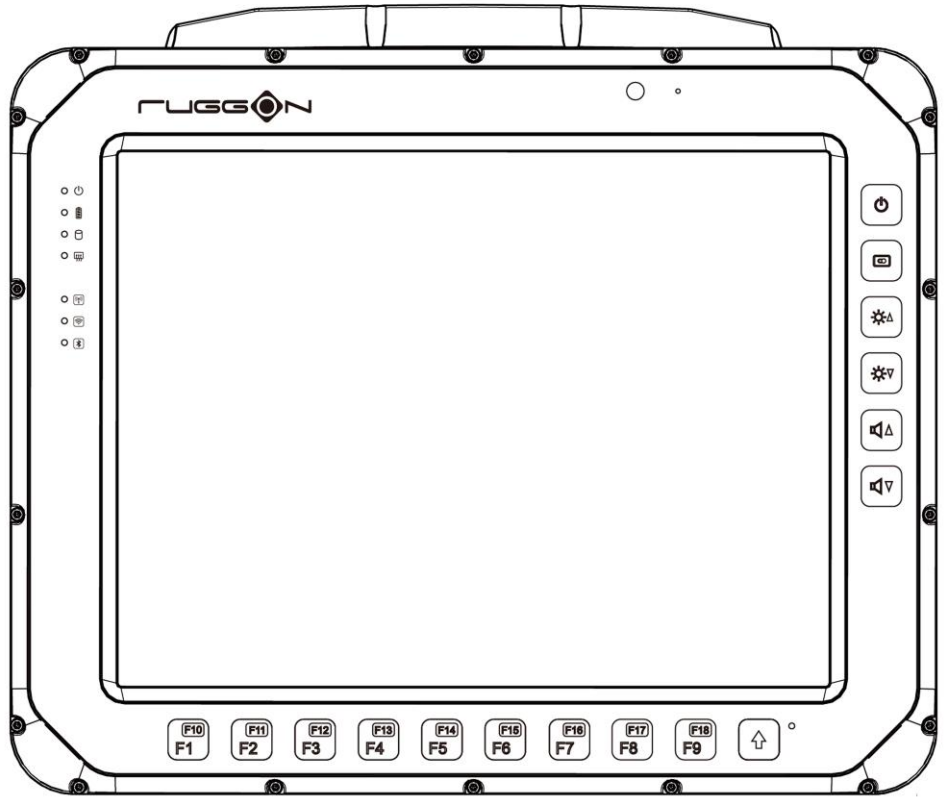
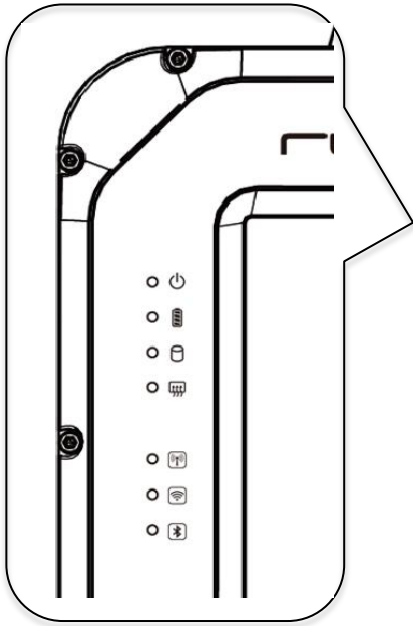

The LEDs on VX-601 are status indicators that show the operating status of your system. The status indicators can help pinpoint possible failed hardware components causing specific symptoms. Refer to the description below.

LED	Status	Description
System	Blink Green	Power up
System	Blink Amber	Load BIOS/ boot loader
System	Solid Green	System ready for use
System	Blink Red	Abnormal vehicle battery
Battery	Slow Blink Orange	Charging
Battery	Off (No light)	Discharging
Battery	Solid Orange	Full Charged
Display/Defrost	Solid Green	Function turn on/defrost function mark (defrost LED light will only be present for defrost versions)
WWAN	Solid Green	Module enabled
WIFI	Solid Green	Module enabled
BT	Solid Green	Module enabled



Adjust the Speaker Volume

VX-601 provides the volume control buttons to adjust the speakers' volume; you can also control the overall level of sound using Windows. When you press the top part of the volume button, it makes the volume louder; pressing the bottom part makes the volume lower

- Press the  button to increase the volume.
- Press the  button to decrease the volume.

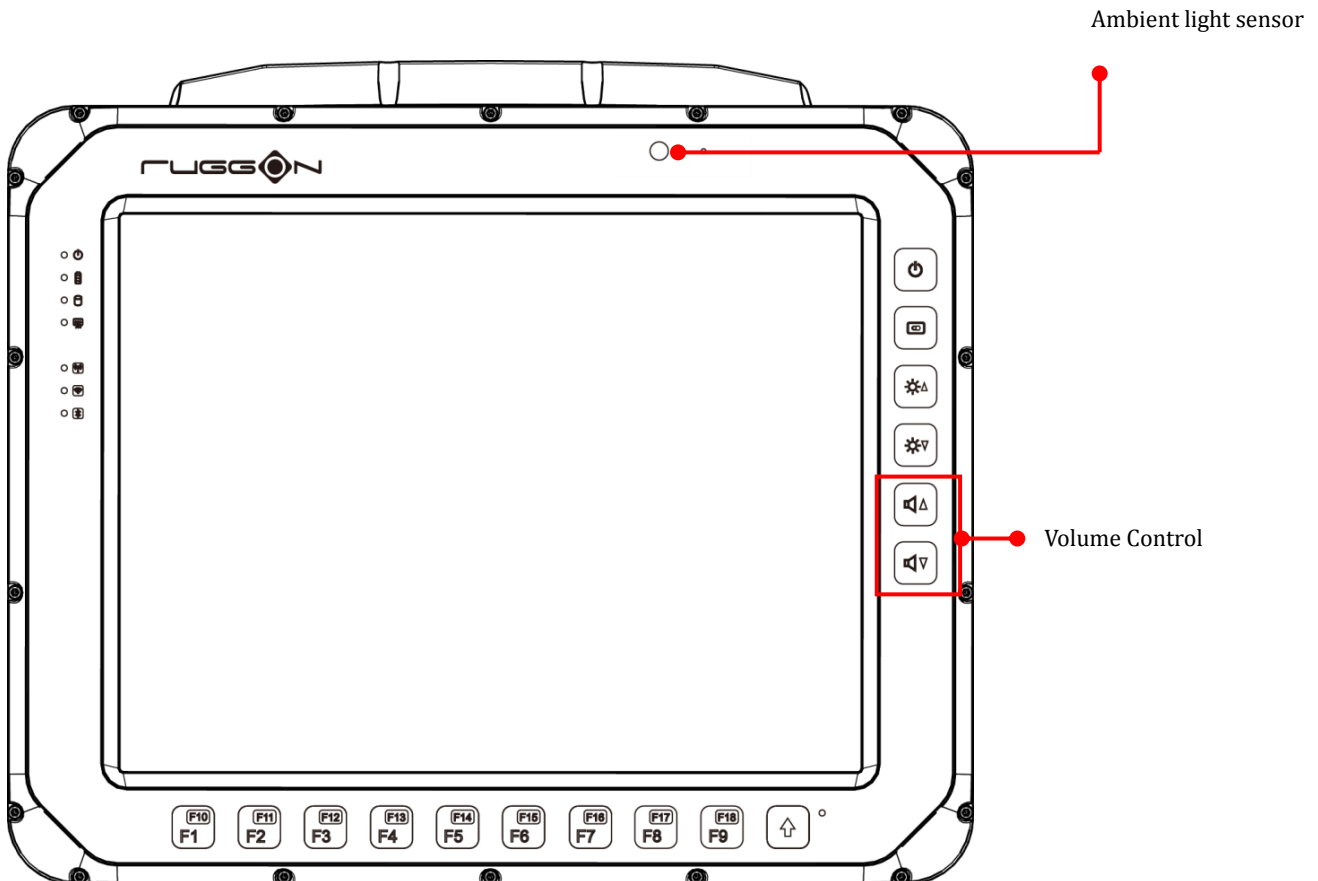



Auto-Brightness Adjustment

When you use VX-601, you may well encounter different lighting conditions that make it difficult to see the information on screen. VX-601's built-in the ambient light sensor on the front panel supports auto-dimming, which you can also disable to manually adjust the brightness; this setting can be done via DashON.

Manual Brightness Adjustment

VX-601 also supports manual brightness adjustment; you can manually adjust the

brightness by pressing the  or  button.

Internal Microphone

VX-601 is equipped with an internal microphone, so you don't need an external one. In addition to the built-in speaker and microphones, you can plug external headsets in the audio jack.

Display on/off

To turn on/off the display, press the display button located on the right side of the terminal.

Defrost on/off (only available upon request)

In environments where an extreme temperature change occurs, the display can frost/fog up due to such a temperature change. To enable the defrost function, press and hold the display button for 3 seconds to turn on /off the function (NOTE: the defrost function is only available upon request). The device can heat up to maximum 35 degrees Celsius. Once the device is at 35 degrees Celsius, the function will automatically shut off. (NOTE: once the device reaches 35 degrees Celsius, the function will automatically shut off. Pressing the defrost key does not re-enable the function.)

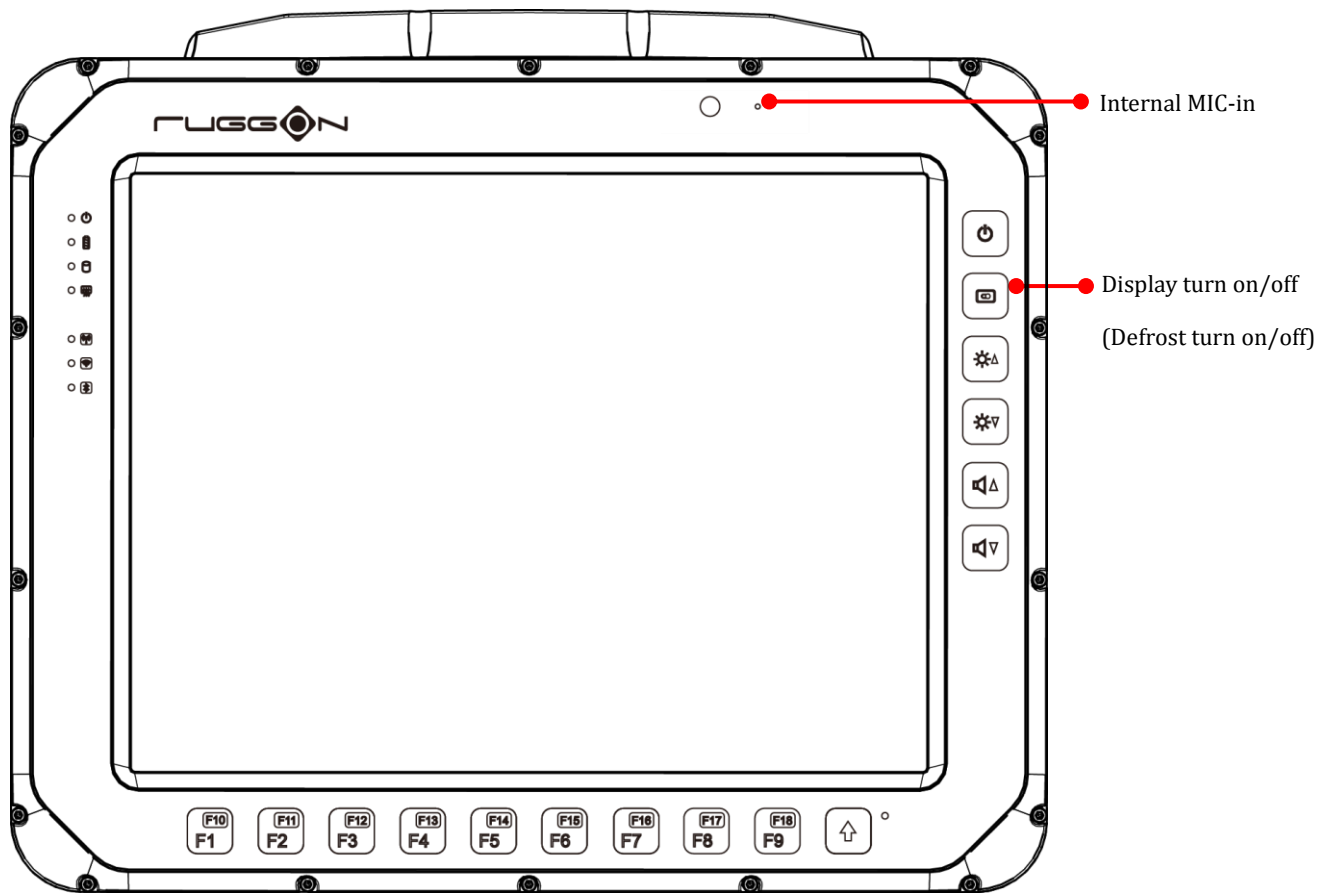

Programmable Buttons

VX-601 provides default commands for nine programmable buttons. You can configure the programmable buttons via DashON to different commands or keyboard shortcuts to better fit your work style.

Power Management

In addition to settings in Windows Control Panel, VX-601 also provides DashON for configuration setting which includes power management and system setup. Please refer to Chapter 6 for configuration setting in DashON.

Chapter 5. Jumpers and Connectors

Bottom View

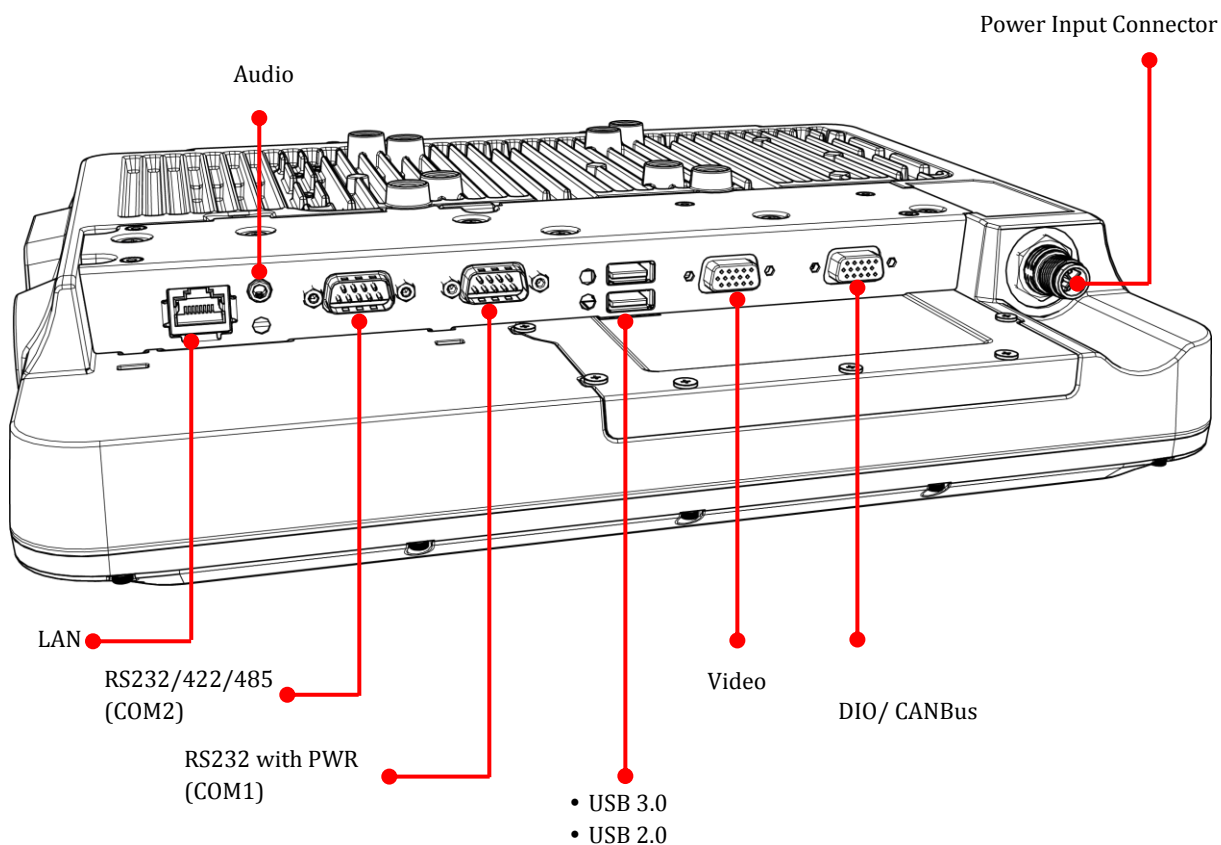

External Connectors Pin Assignments

Use this section as a reference for the pin assignments of the various ports available on the VX-601.

Power Connector

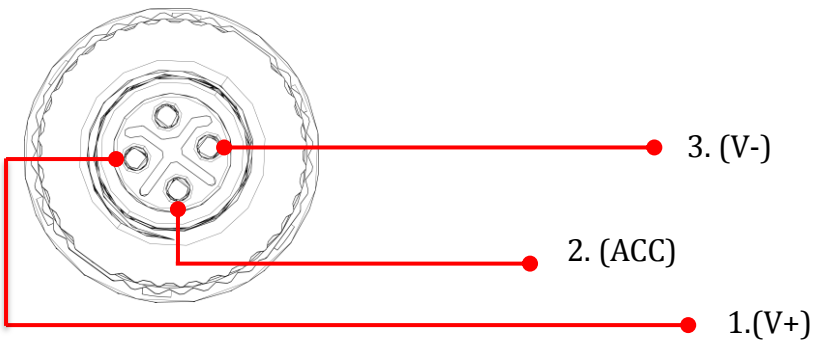

Pin	Signal
1	V+
2	ACC
3	V-

Note: Please refer to Section 1 in Chapter 4 for connecting the external power cable to power source.

RS-232 Port (COM1)

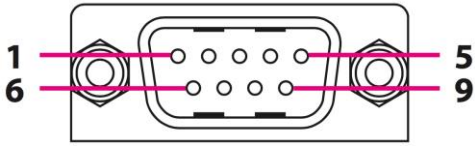

Pin	Signal	Description
1	DCD	Data carrier detect (input)
2	RXD	Receive data (input)
3	TXD	Transmit data (output)
4	DTR	Data terminal ready (output)
5	GND	Signal/power ground
6	DSR	Data set ready (input)
7	RTS	Request to send (output)
8	CTS	Clear to send (input)
9	PWR	Power output for 0/5/12V 600mA

RS-232/422/485 Port (COM2)

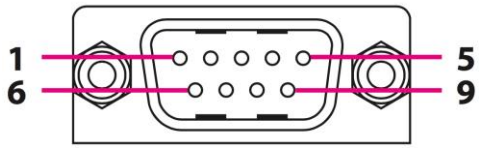

Pin	RS232	RS485	RS422
1	DCD	TX-	TX-
2	RXD	TX+	TX+
3	TXD		RX+
4	DTR		RX-
5	GND		
6	DSR		
7	RTS		
8	CTS		
9	RI		

Digital I/O, CANbus and DR Port

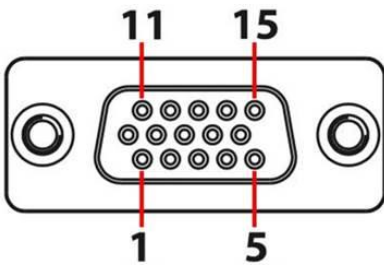

Pin	Signal
1	CAN_H
2	NA
3	NA
4	FWD
5	WHEELTICK
6	CAN_L
7	NA
8	NA
9	NA
10	GND
11	ISO_GND
12	ISO_DIO_OUT1
13	ISO_DIO_IN1
14	ISO_DIO_IN2
15	ISO_DIO_OUT2

Video Port

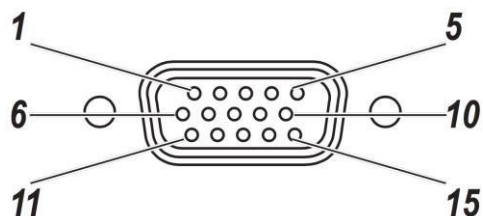

Pin	Signal	Description
1	CH1: Audio Left	Audio left input
2	CH2: Video	Video input
3	CH2: Audio Right	Audio right input
4	NC	No connected
5	CH3: Audio Right	Audio right input
6	CH1: Video	Video
7	CH1: Audio Right	Audio right input
8	CH2: Audio Left	Audio left input
9	CH3: Video	Video
10	CH3: Audio Left	Audio left input
11	CH4: Video	Video
12	GND	GND
13	CH4: Audio Left	Audio left input
14	CH4: Audio Right	Audio right input
15	GND	GND

Chapter 6. Key Mapping

Please refer to the following chart for key mapping.

Key Button	App Get Key (code 1)
F1	E0 55
F2	E0 56
F3	E0 57
F4	E0 6E
F5	E0 12
F6	E0 13
F7	E0 14
F8	E0 15
F9	E0 16
F10	E0 1B
F11	E0 1E
F12	E0 1F
F13	E0 23
F14	E0 25
F15	E0 26
F16	E0 27
F17	E0 28
F18	E0 29

Chapter 7. DashON Setting

You can use DashON to configure the device for your demo or test. We also provide the corresponding SDK for your application development. DashON will auto-run in background while the system turns on. This section is to brief you on what functions are included in DashON and how to set up based on Windows OS.

1. Device Information

It provides information of the system hardware, software, and firmware version.

2. Vehicle Status

This section is to demo how to read the vehicle information such as vehicle battery voltage, fuel, speed and so on while connecting with vehicle SAE J1939. We use a simulator to run the demo.

3. Communication Setting

This is to enable / disable Wi-Fi/BT/WWAN and configure the related setting.

4. System Status & Setting

This section contains the major configuration of the system device. Power management, wake up event, IO configuration, brightness and watchdog timer setting are included.

5. Location & Sensor

GPS configuration setting and temperature status

Double click on the DashON icon if DashON is not running in background

Device Information

Click on the “Device Information” icon

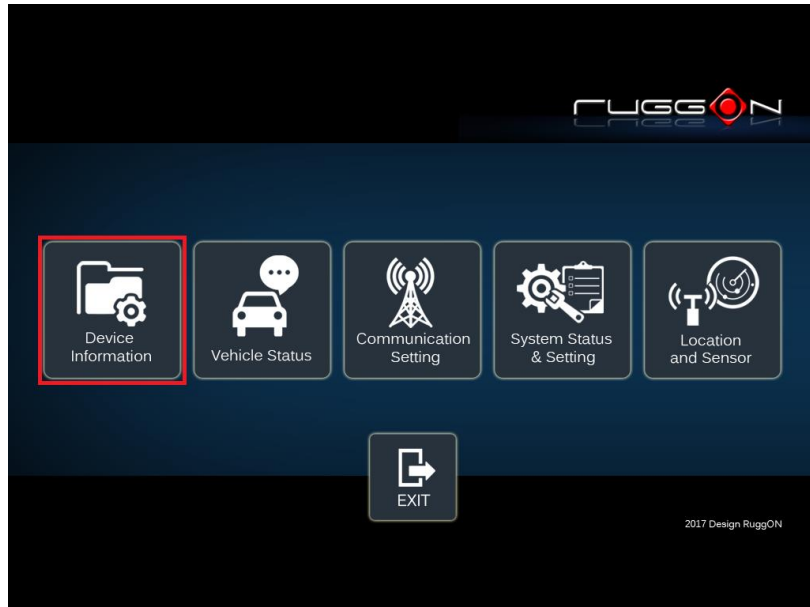

In device information, you can see the PCBA version, DashON utility version, BIOS version, EC version, and system model name.



Vehicle Status

Vehicle status shows some vehicle information from the simulator.

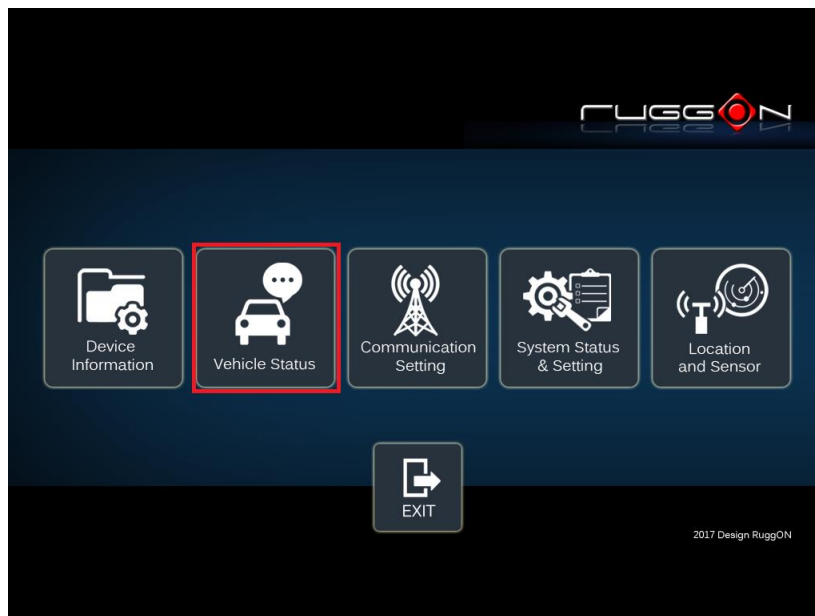

The related AT command is available upon request. Please contact local sales representatives or login to the support website.

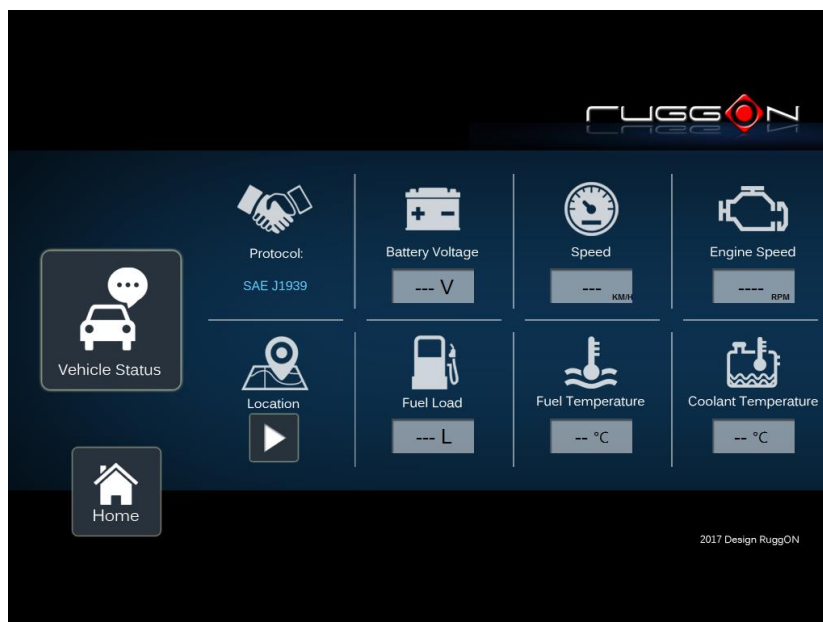

Communication Setting

Communication setting allows you to enable/ disable Wi-Fi/WWAN/Bluetooth via DashON utility. Please click on the “Communication Setting”

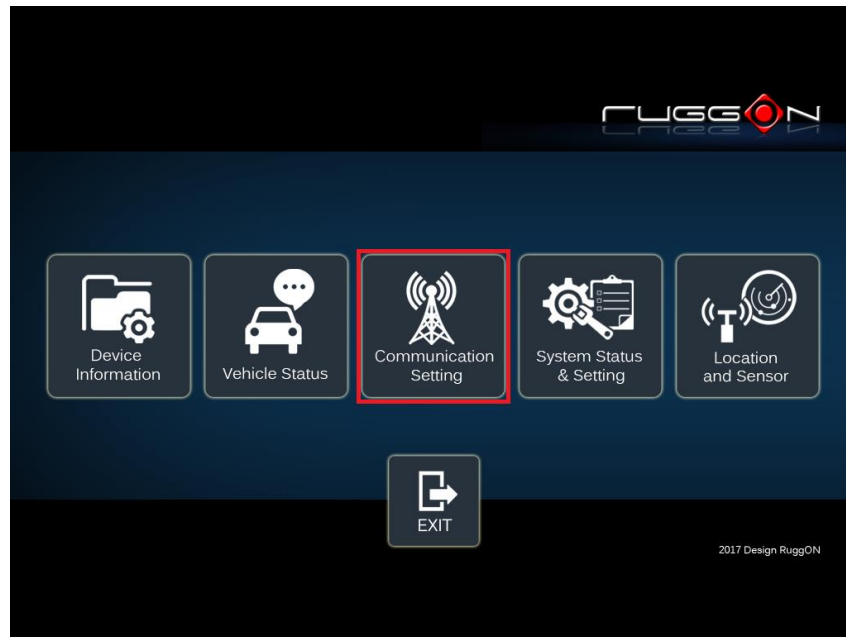

Enable/ Disable Module

Item 1. Click on the switch bar to **Enable/ Disable** Wi-Fi and Bluetooth function.

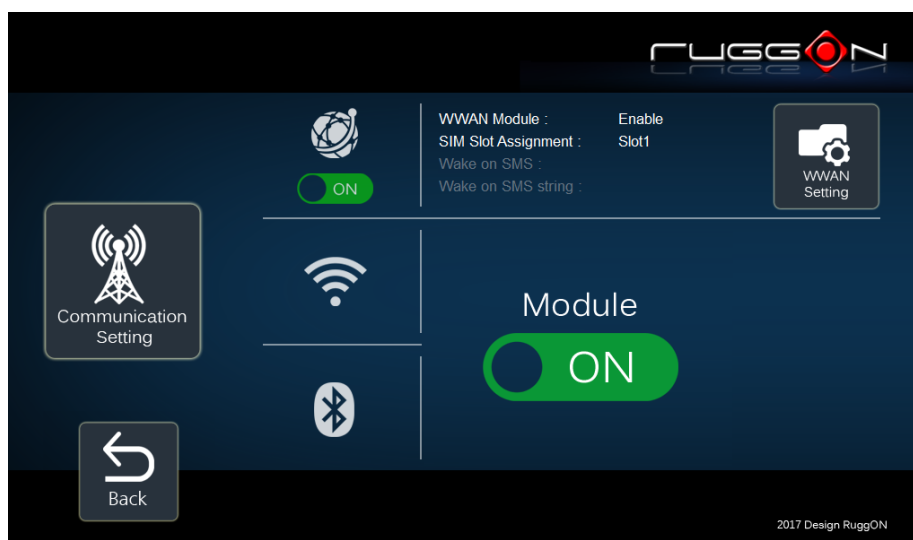

WWAN Communication Setting

If WWAN module is present in the device, you can click on “WWAN setting” to get into the detailed setting.

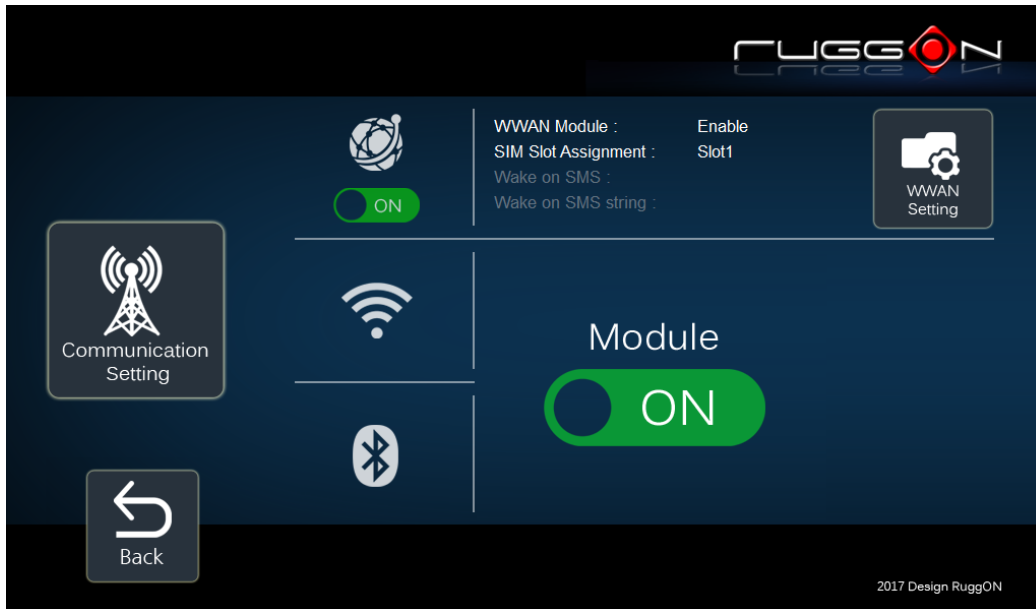

You can set the two major features including WWAN RF on/off and SIM slot selection.

1. Module RF Enable/ Disable: to enable or disable the WWAN RF transmission.
2. SIM slot assignment: This feature is only available for the device with multiple SIM slots.

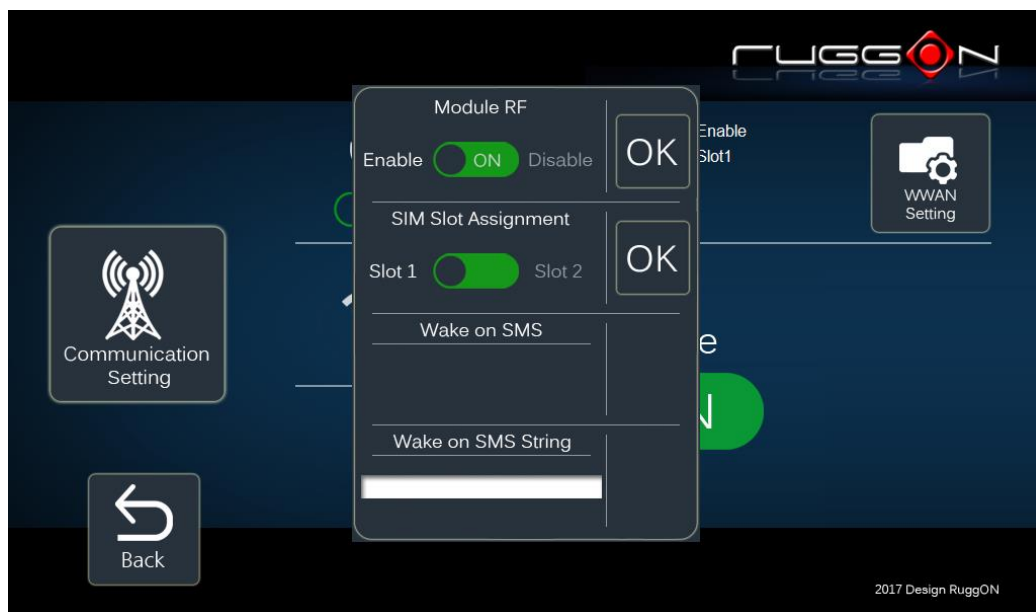

System Status & Setting

This section is to set and read the system status. It covers power management, internal backup battery, IO configuration, wake up event and so on.

Power Management Setup



Please click on the “Power Management”

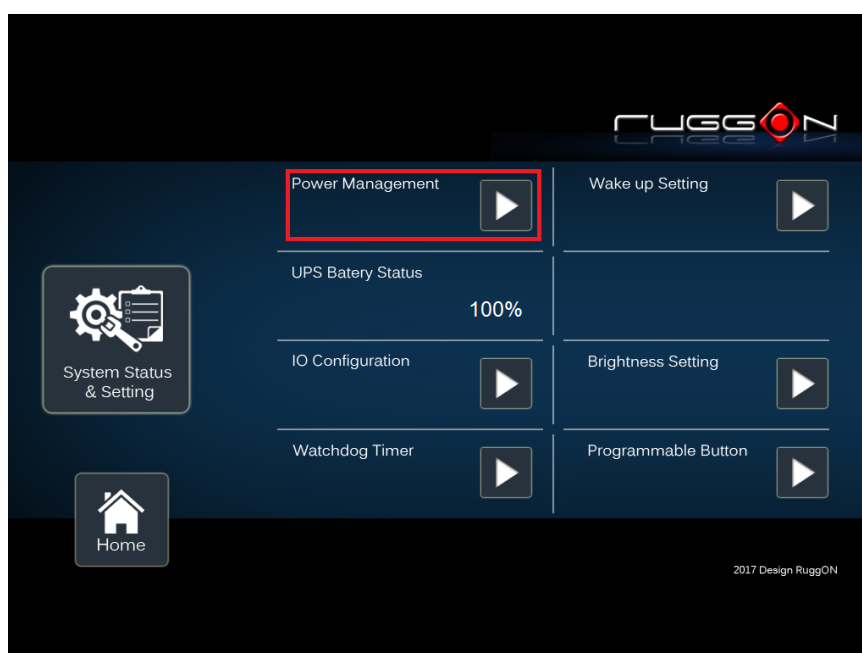

ACC Detection Setting

In VX-601 design setting, it supports ACC sense. You can check its status from ACC status. Default is non-ACC mode.



Input Voltage Setting

Click on the  to the input voltage selection.

You can select the power input voltage either 9~60V or 12V, 24V, 36V or 48V. If 9~60V is selected, it means the system can be powered on while the voltage ranges from 9~60V.

Please note if you use a 19V power adapter, the input voltage must be selected to 9~60V.

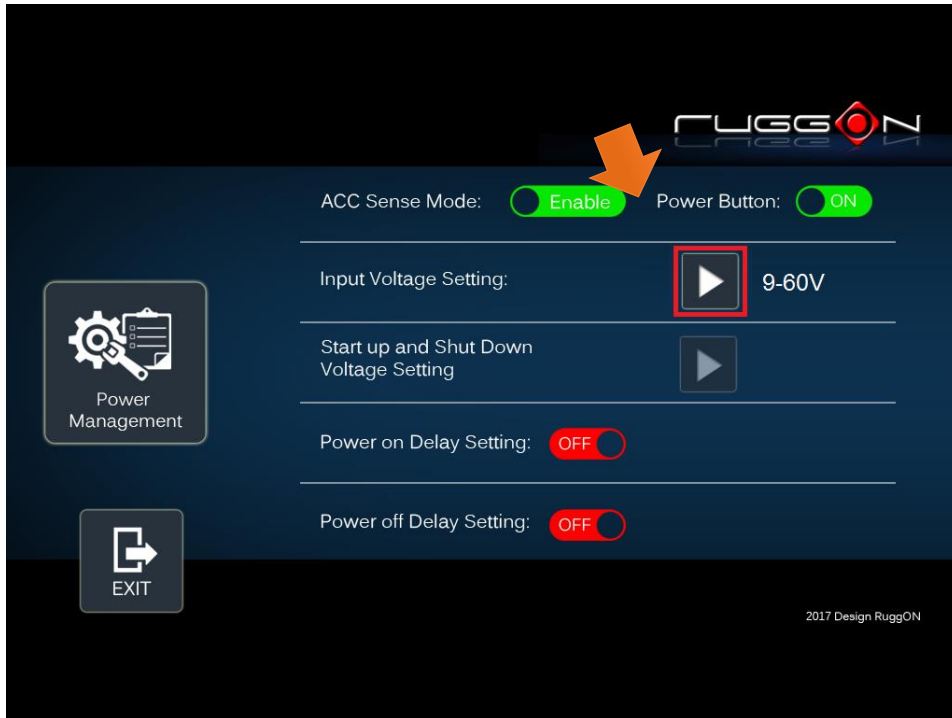

If 12V, 24V, 36V or 48V is selected, you can also select the startup and shut down voltage setting.

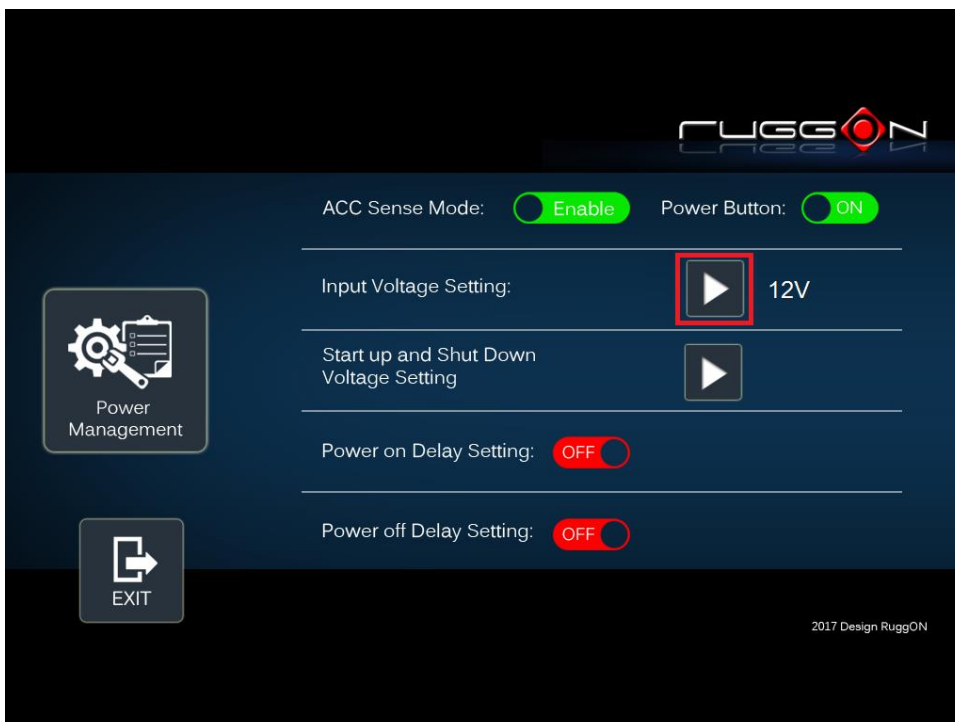



If the above selection items do not meet your demand, please contact local sales representatives.

Power On/Off Delay Setting

Power on delay function enables you to power on the device after the ACC is on for a specified period of time. Enabled power off delay function lets the device remain on until the ACC is off for a specified period of time.

Power On Delay

You can set the system startup time after ACC is on.

Switch the  to , click on the , and you will see the selection list. Delay time can be set at 10sec/30sec/1min/5min/10min/30min/60min/6hr



Power Off Delay

You can set the system shut down time after ACC is off.

Same as power on delay setting process; you can also set the power off delay.

Delay time can be set at 10sec/30sec/1min/5min/10min/15min/30min/60min

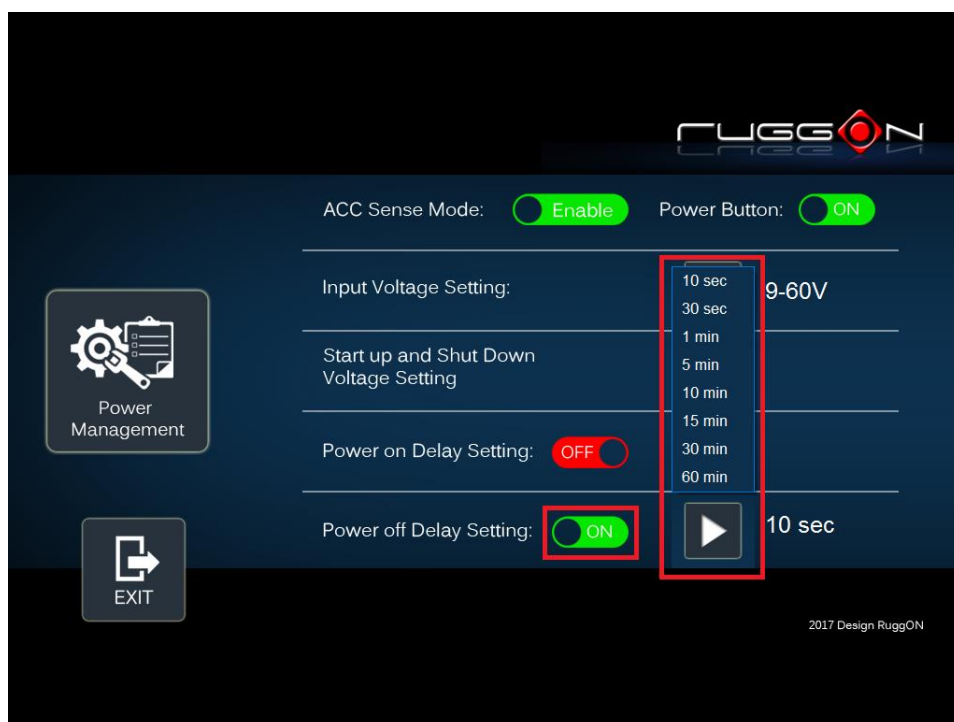

Wake up Setting



In addition to ACC sense, two wake-up events are able to power up the device. They belong to RTC wake up. Here is the setting method.

“System Status & Setting”-> “System Status & Setting” ->”Wake up Setting”

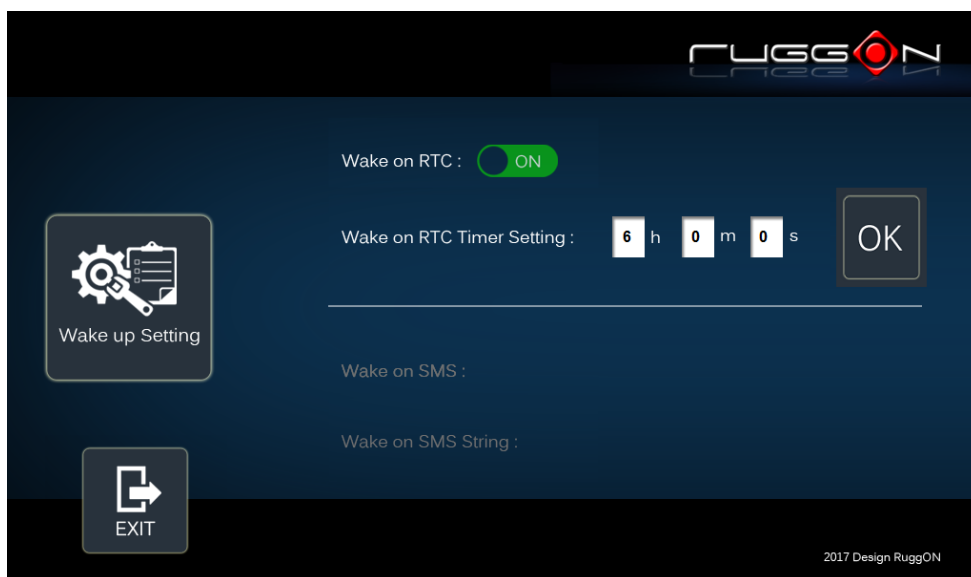
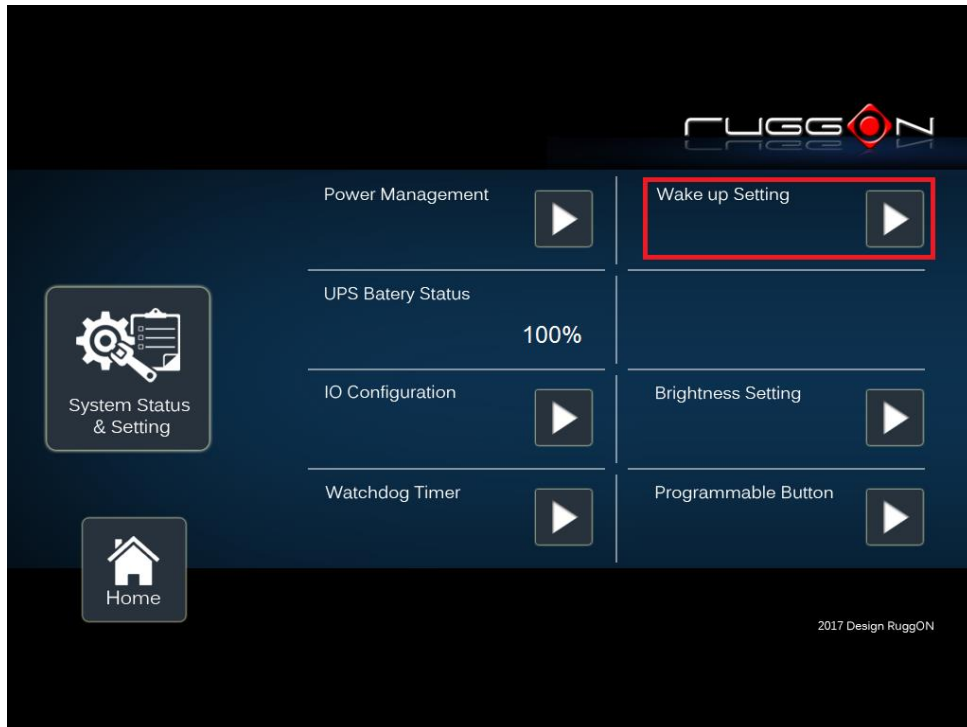
In Wake up setting, you can find “Wake on RTC” setting



RTC wake up setting

Click on the  to , you can find RTC timer setting to set the desired time to power up the system.

After you have finished with the setup, click on the “OK” to save the value. For example, if you set 06:00:00, it means the system will be powered up at 6 o'clock in the morning.

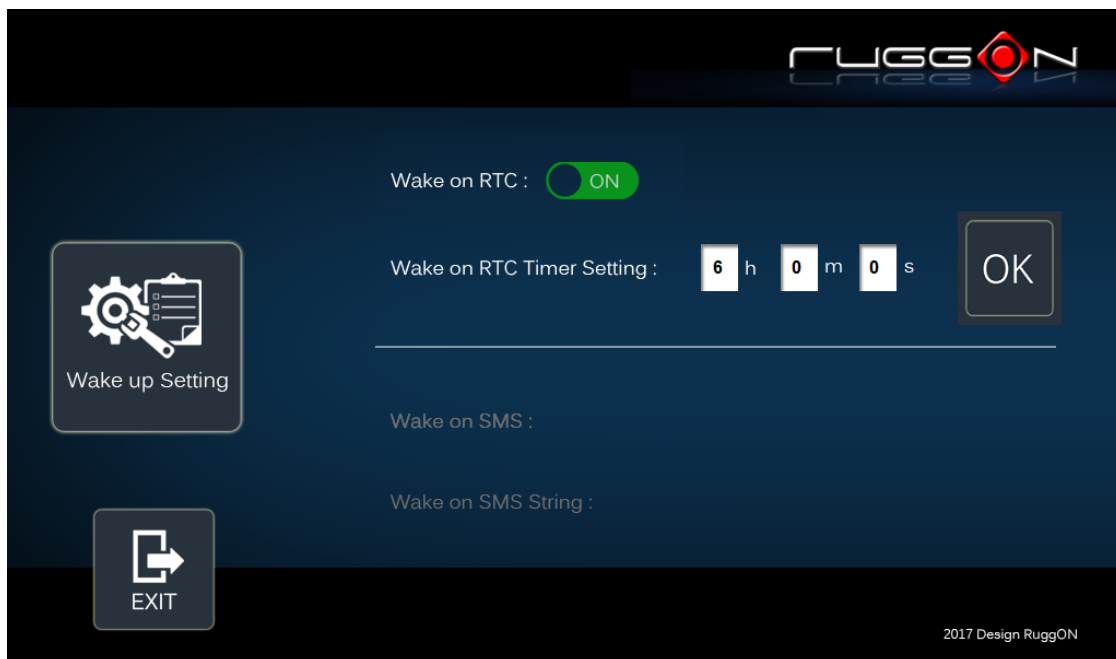

I/O Configuration

Please click on the I/O Configuration

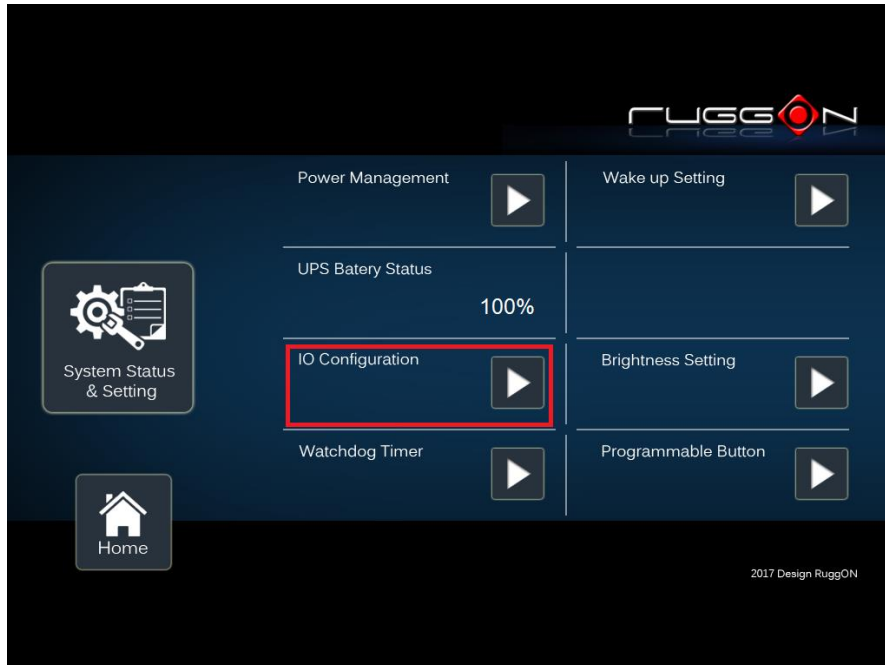

COM1 Setting

RS232 (COM1) supports 5V or 12V power output for users to easily connect with barcode scanner or other equipment. The maximum current is up to 600mA.

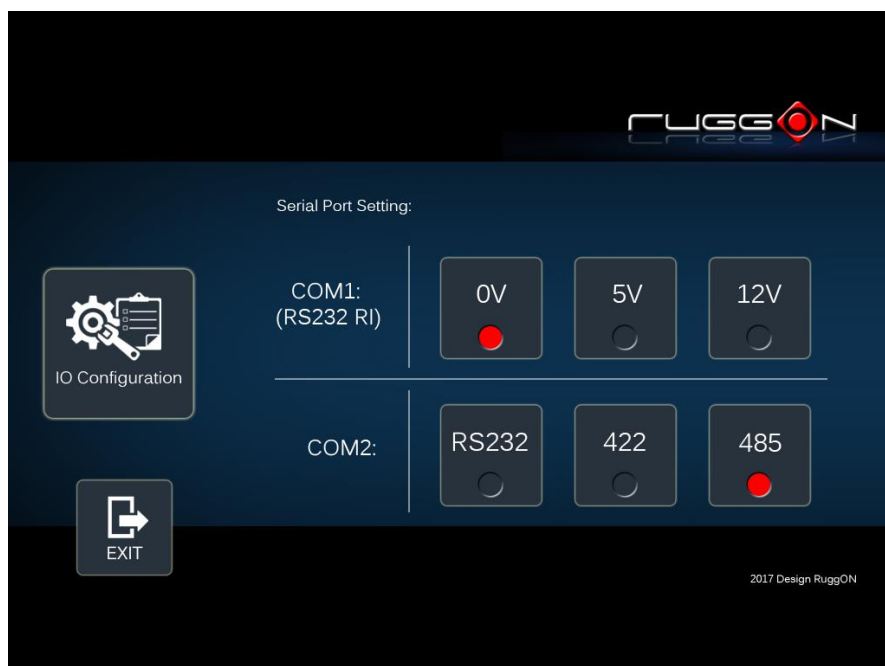

If you don't need the power output, just select 0V output to avoid the equipment damage. Please note if system power source is from backup battery (no DC input available), COM1 will stop supplying the power output.

COM2 Setting

The COM2 includes RS-232, RS-422 and RS-485 signals. Please select your required items and connect the Y-cable converter to the system. Please refer to the pin out description for correct connection.

Brightness Setting

Brightness adjustment is to optimize the operation of the backlight LEDs under a variety of daylight conditions. VX-601 supports auto-dimming and manually adjusts the brightness. If auto-dimming is enabled, the brightness is auto adjusted along with the changes of environmental light. You can also manually change the display brightness via programmable buttons or the bar adjustment in DashON. For programmable button setting, please see "Programmable Button" section. VX-601's display brightness is set to automatic adjustment. You can also turn off "Auto-Dimming" and drag the scroll bar to adjust display brightness.

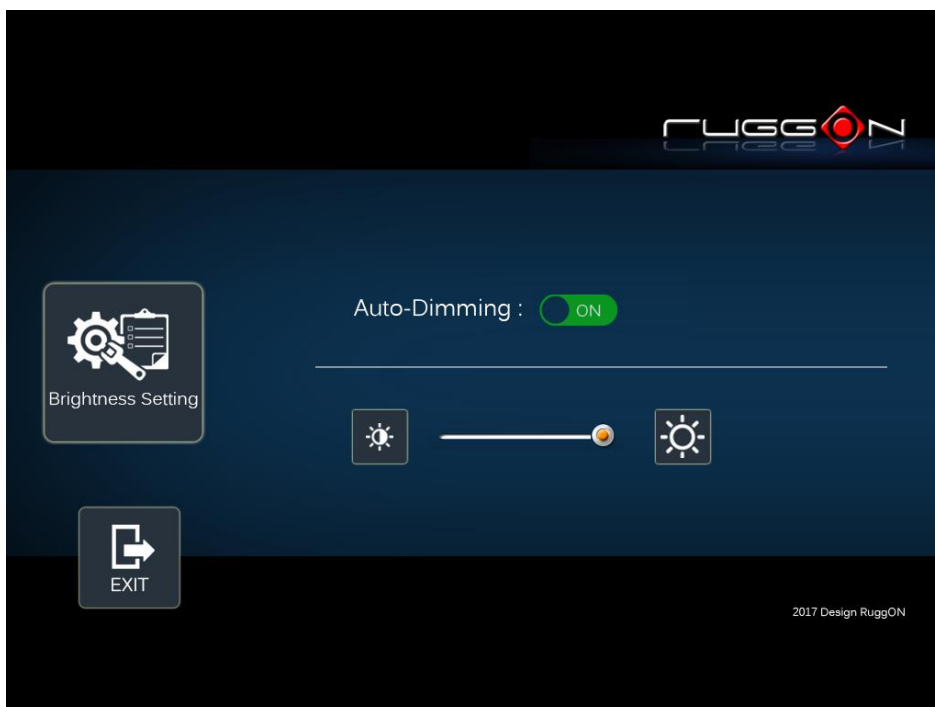

Watchdog Timer

This section is about the timer setting of watchdog and the simulation of watchdog functions. When the system is hanging due to some reasons, you are able to reboot the system automatically after the set time frame.

Double click on the DashON icon, and then click on the 4th icon “System Status & Setting”.

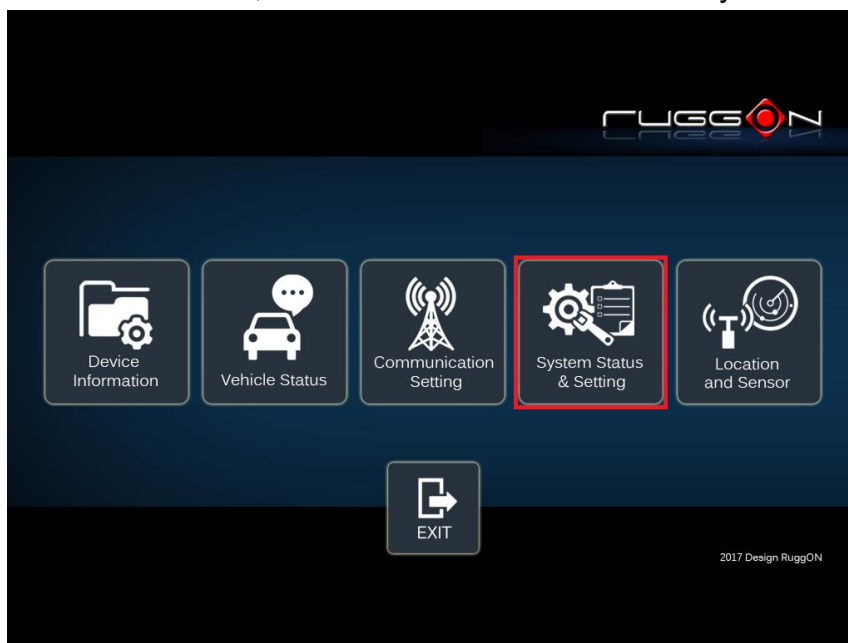

Click on the “Watchdog Timer”



Select the timer setting.

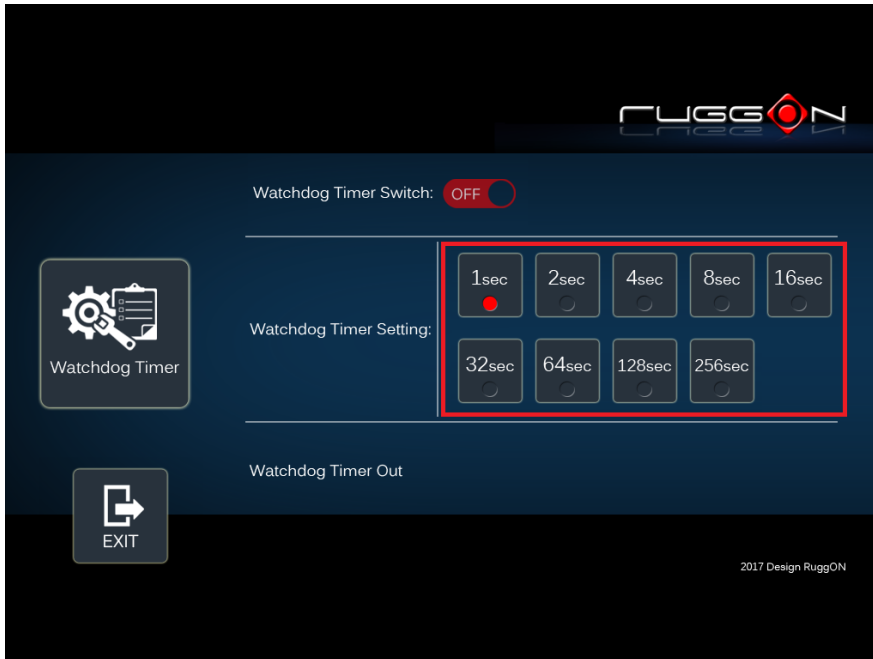

Turn on the watchdog switch.

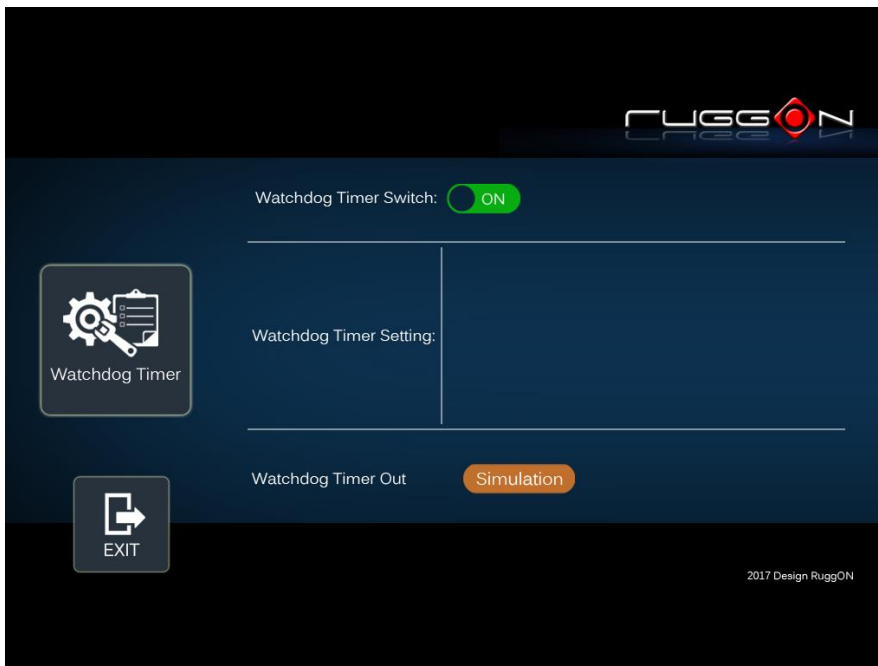

If you'd like to test if watchdog timer is enabled and working, please click on the "simulation" icon. The "simulation" is to simulate the system on hang and reboot it after the set time frame.

Programmable Button

Programmable buttons can be set to different functions per user's definition.

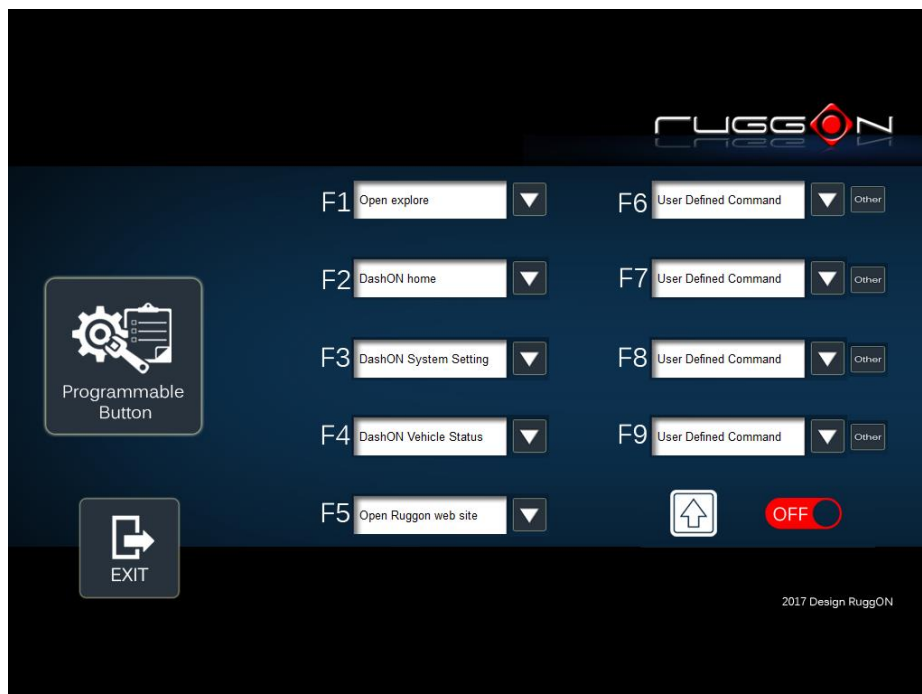
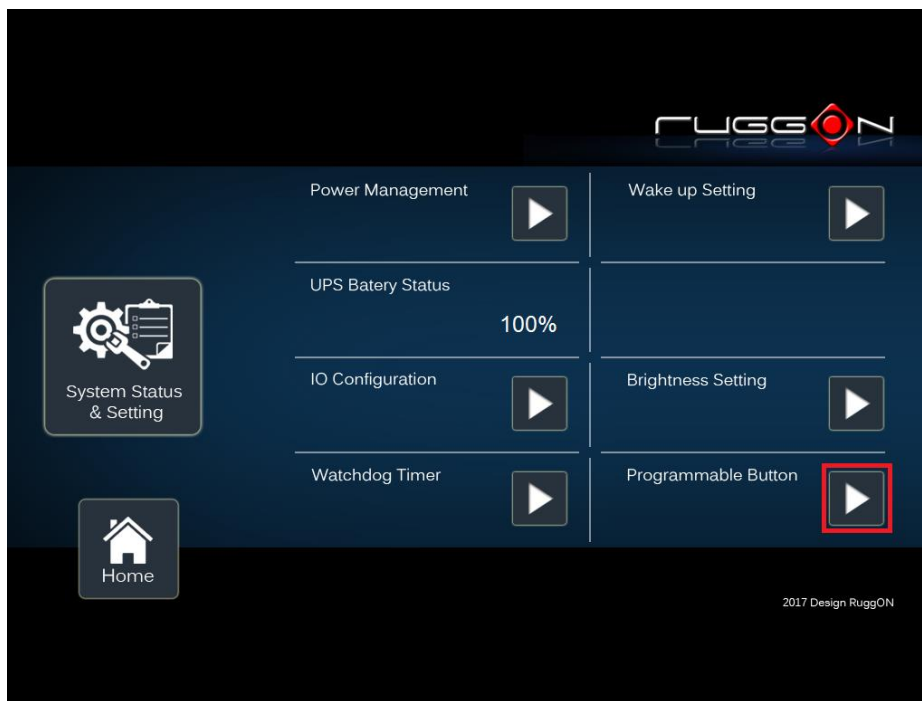

Select which function key button you want to set and then click on the  to select the function from the list.

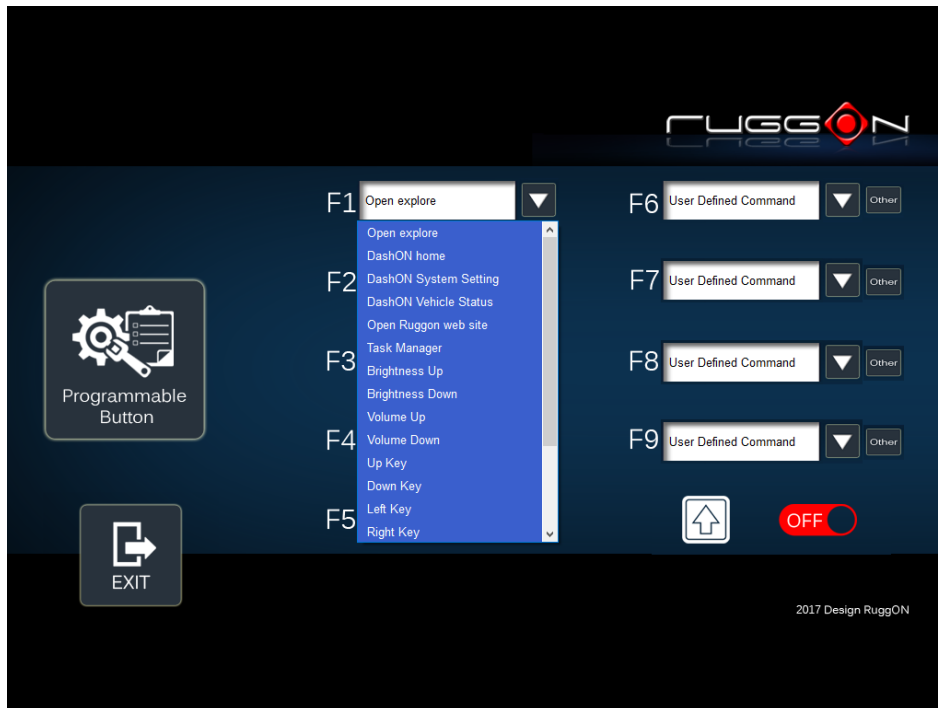

User can also define the keystrokes for function keys by selecting the “User Defined Command” from the list.

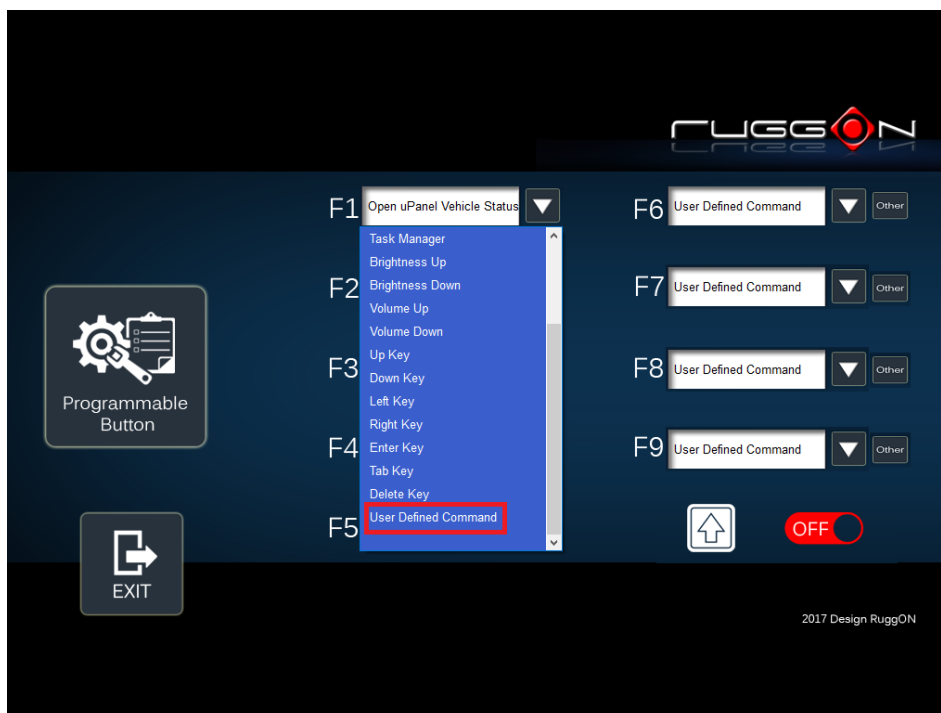

Click on the “Other”

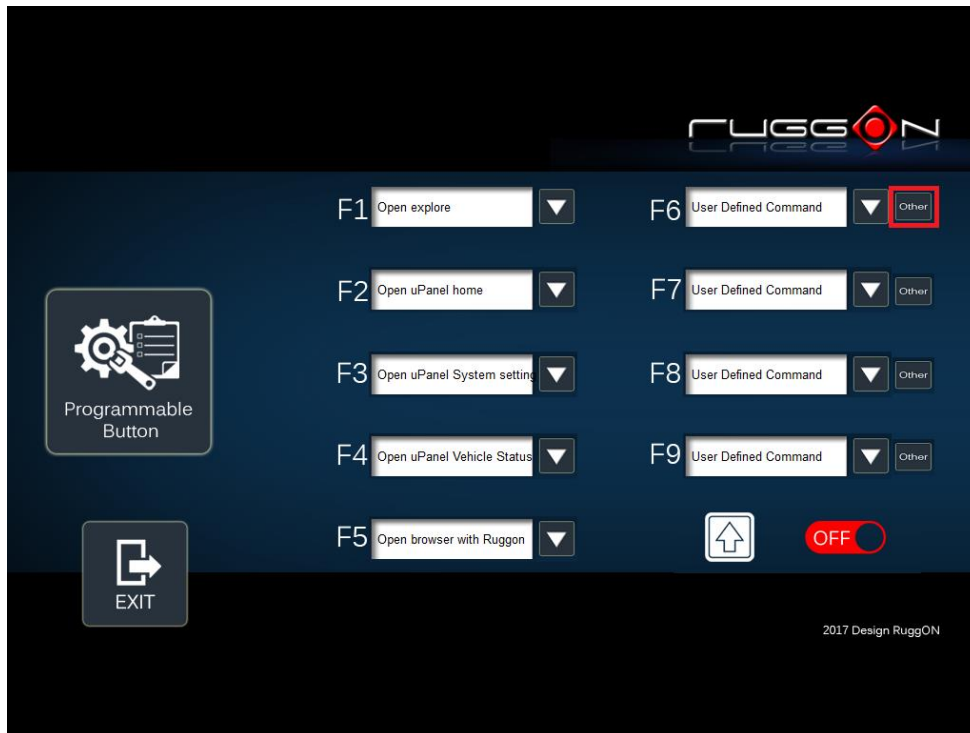

Click on the folder icon to find the program files and then click on the “Save” to save the setting.

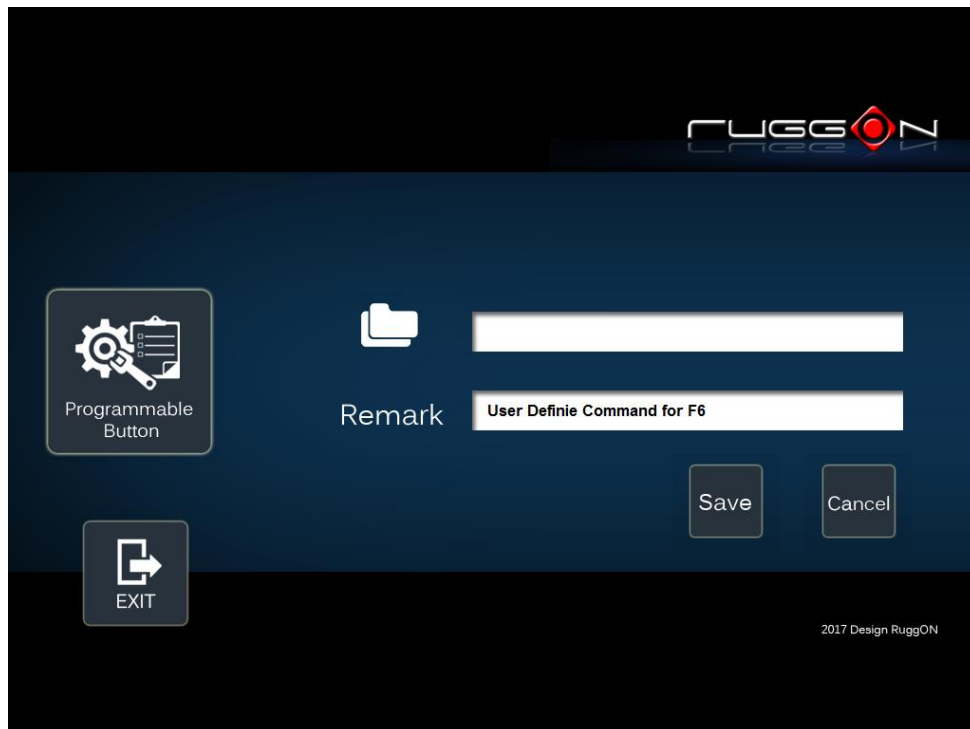

Location and Sensor

VX-601 provides the GPS receiver and G-Sensor built-in. DashON provides both setting and information and also links to the Google map locations for demo applications. You can also use the general freeware GPS viewer to set GPS setting.

Click on the “Location and Sensor”

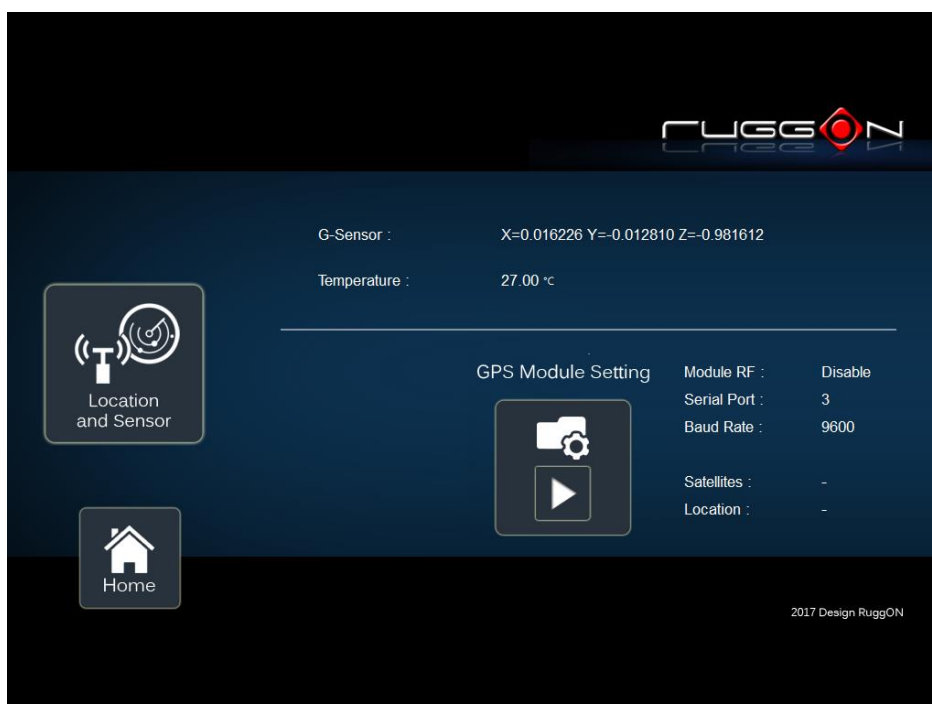
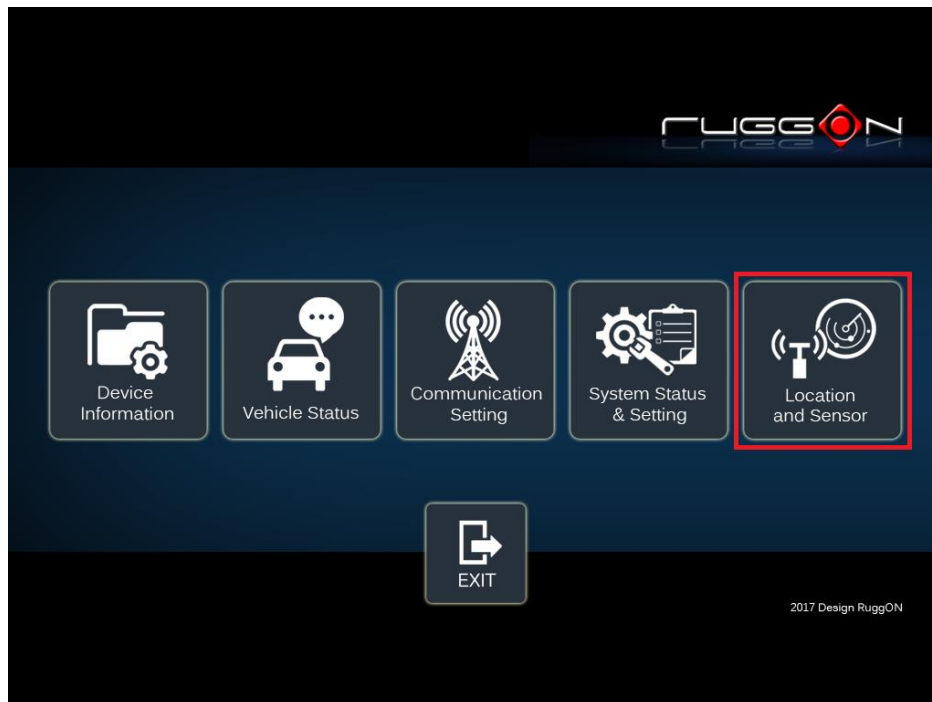

DashON includes the GPS receiver setting information, click on  to set the GPS.

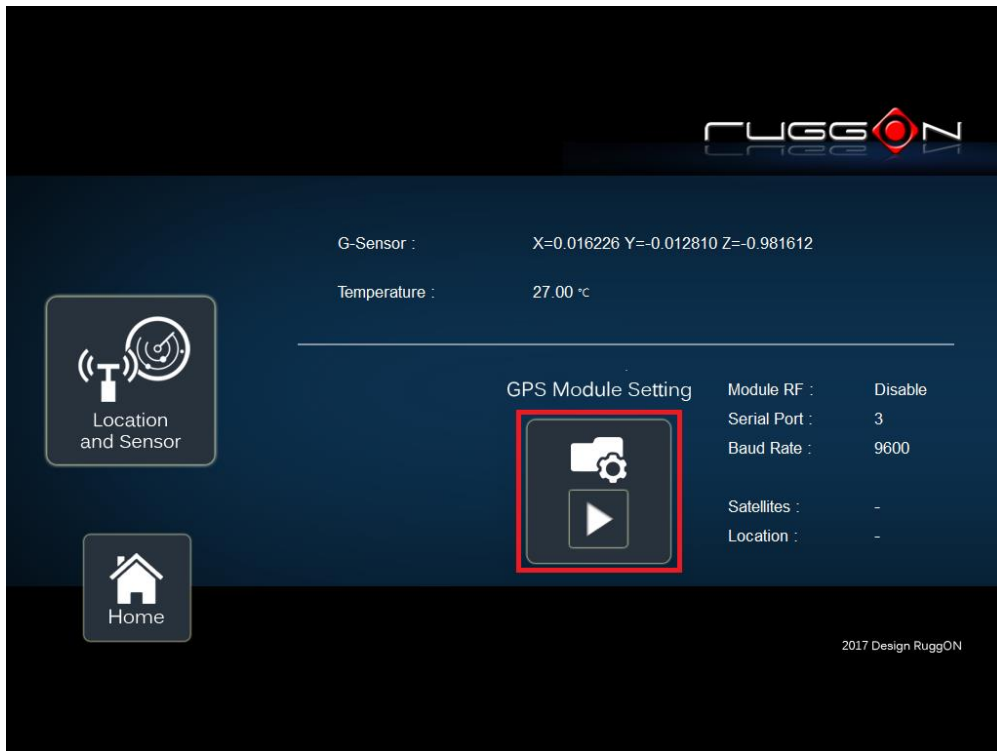

After click on , you will see the following setting screen. The following is the function description.

Module RF: to enable or disable the GPS receiving function.

Serial Port Setting: to set COM port for GPS module connected on.

Baud Rete Setting: to set the baud rate speed.

Satellites: a GPS receiver uses satellites to pinpoint locations; click here to check the receiver performance.

Location: to get GPS coordinates and display them in the Google Maps



Enable/ Disable GPS Receiver

The default GPS receiver is enabled in VX-601. If want to disable the receiver, switch

“Module RF” to .

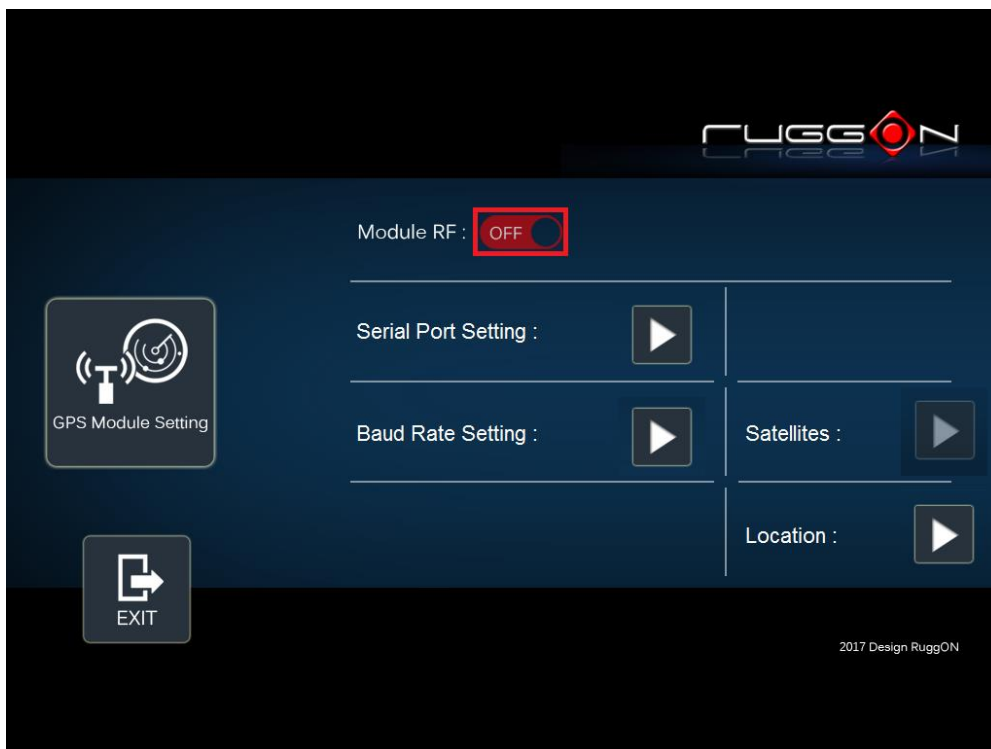

Serial Port Setting

By selecting a COM port, you use the port from the list to connect to your GPS. VX-601 uses COM3 as its default setting for GPS receiver.

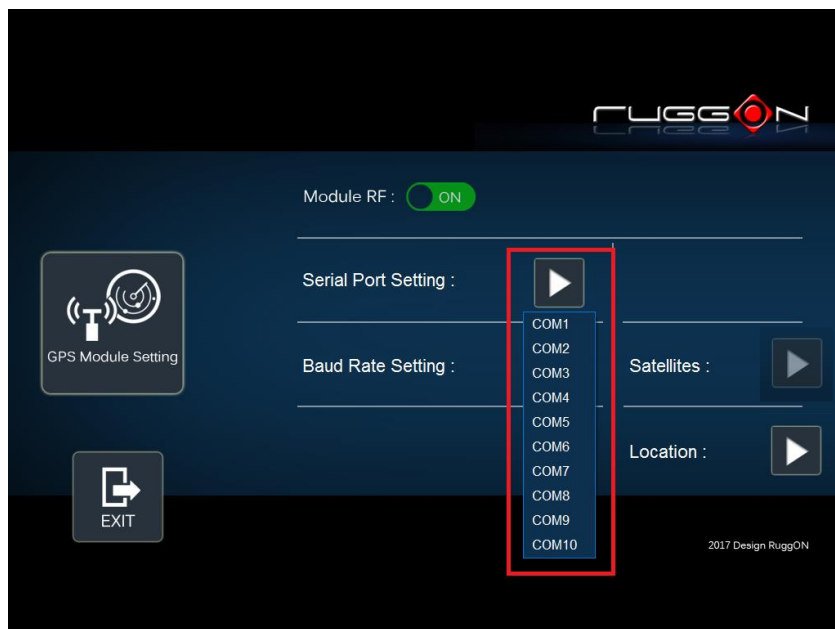

Baud Rate Setting

It must be set to the same baud rate you are using in the GPS receiver. Use as high a Baud rate as possible. Baud Rates from 4800 to 115200 can be selected in DashON. The default is 9600.

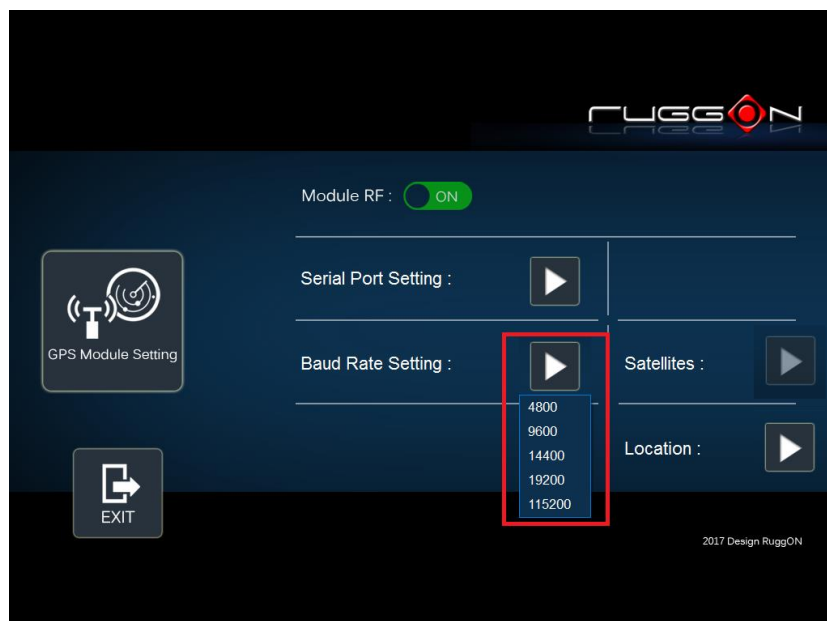

Chapter 8. Main BIOS Setting

VX-601 is equipped with a Phoenix BIOS, which is stored in EEPROM chip.

This chapter provides information for BIOS main feature setting in hardware system.

When the system turns on, press <F2> to enter Setup

The system displays the BIOS setup interface; you can select functions according to what you want to change.



Set Boot Sequence

This section enables users to define and modify the boot options of bootable devices.

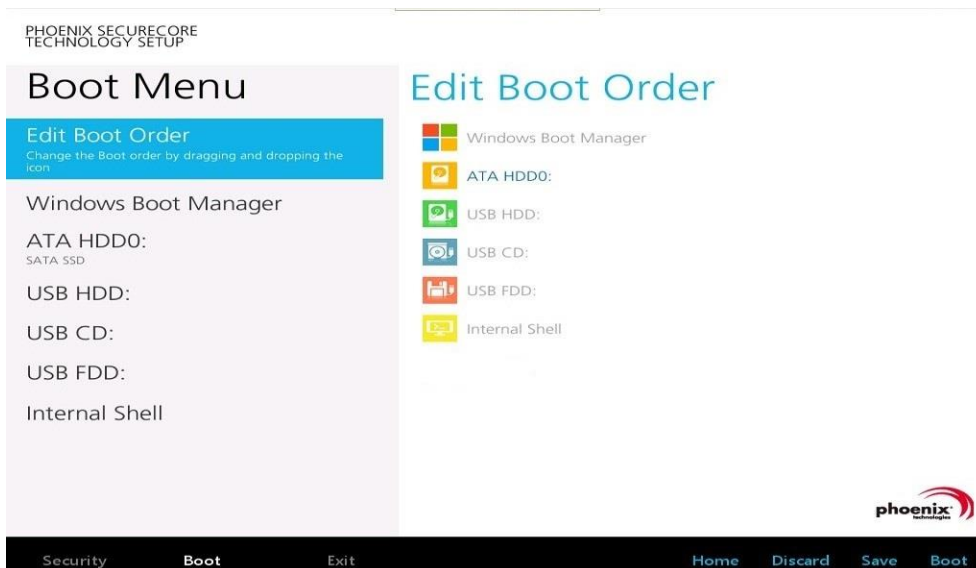

Set the system configuration

Use the Main menu for basic system configuration; users can set the system's date, time, drive parameters, and related settings via the HDD Sub-menu.

Setting the System Date

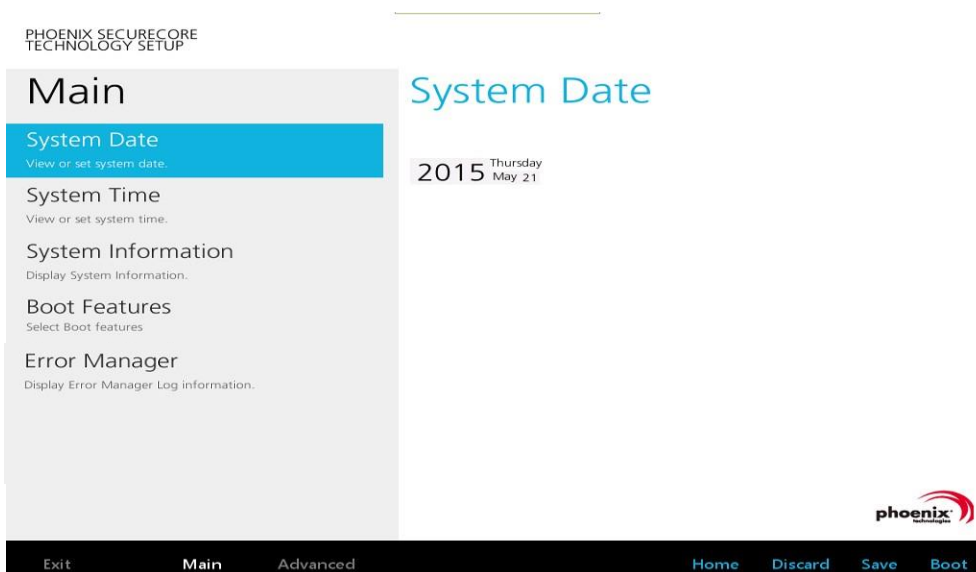

Setting the System Time

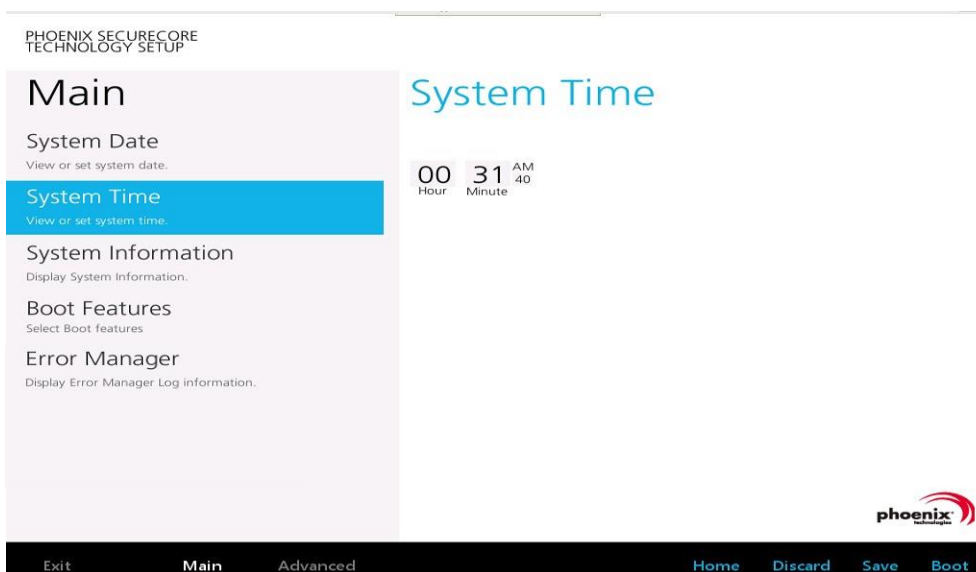

System Information

It displays the system configuration information such as CPU, Memory size, firmware version.

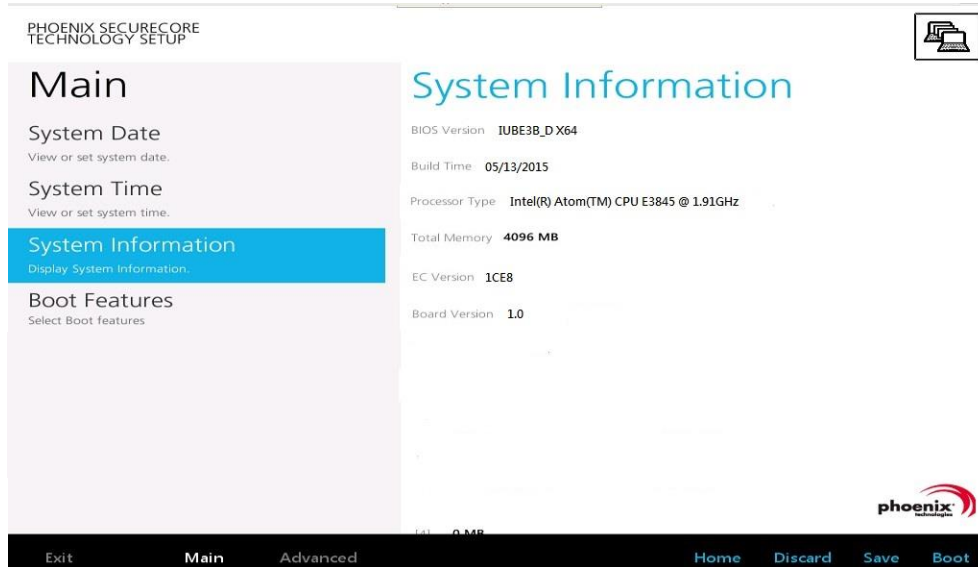

Boot Features

Users can set the boot options for CSM support or Quick Boot. Note if the operating system is Windows 8, please set the Boot Features [Off] for “Legacy Boot”

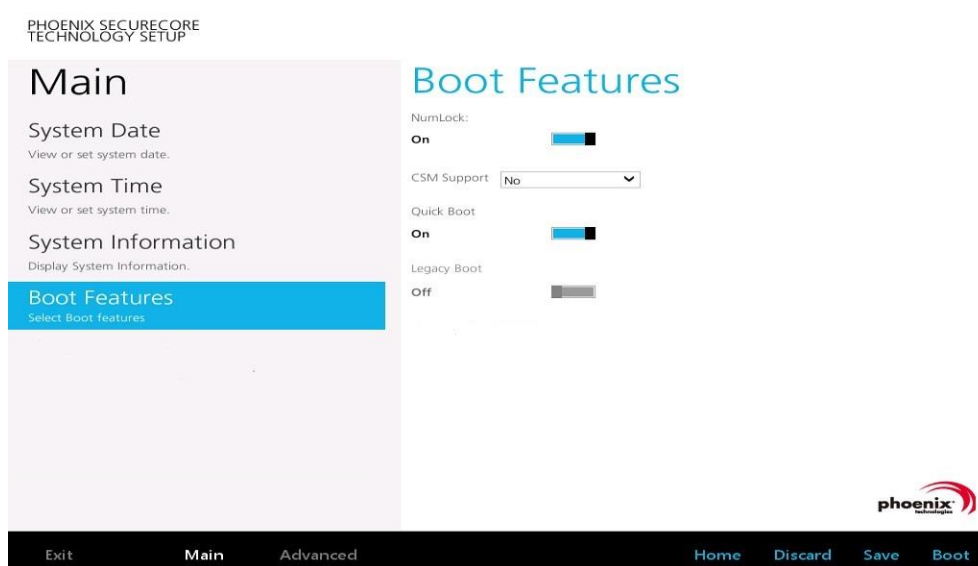

Miscellaneous Configuration

Use Advanced menu to set the system I/O device function.

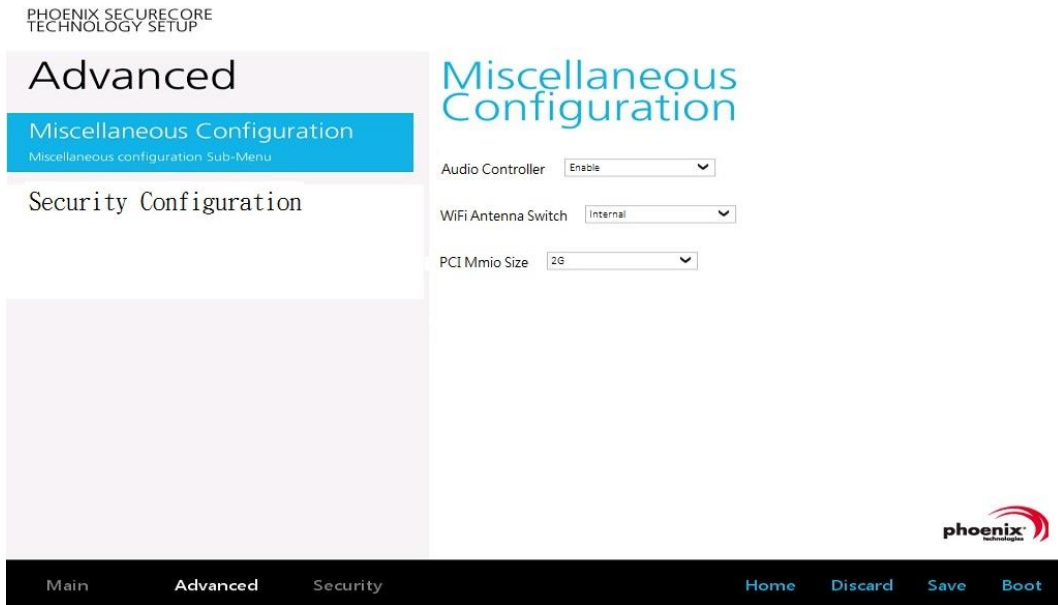

Account's Password Setting

Use the Security Menu to establish the system password and protection for entering the BIOS or system start-up.

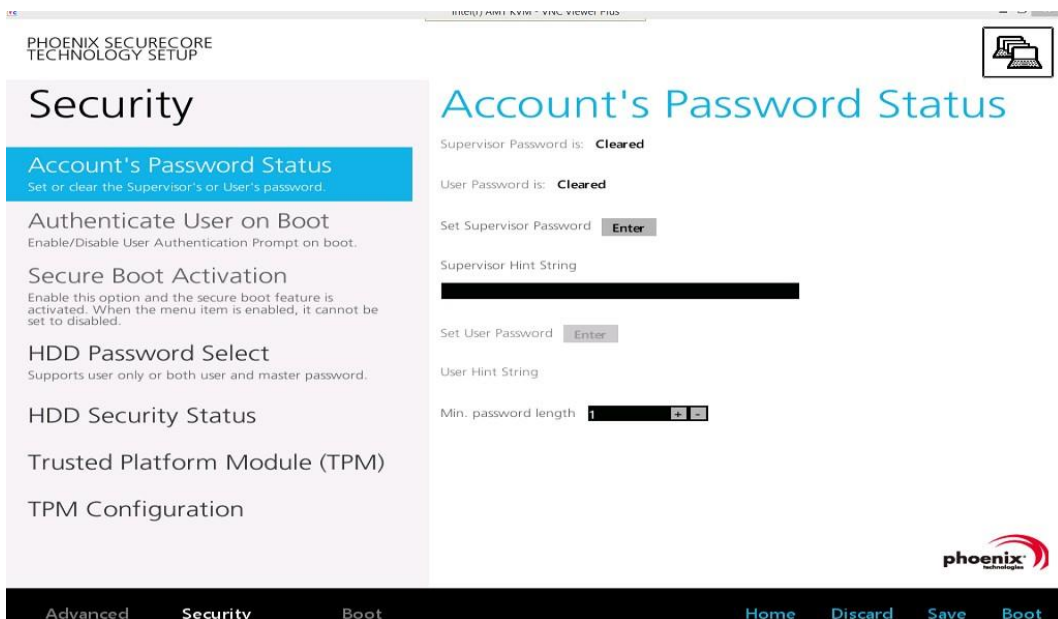

HDD Security Setting

To establish password protection to restrict access to the contents of the hard disk drive, the HDD password is written to the system BIOS and to the hard disk drive to ensure that the password can protect your hard disk drive should it be moved to another computer.

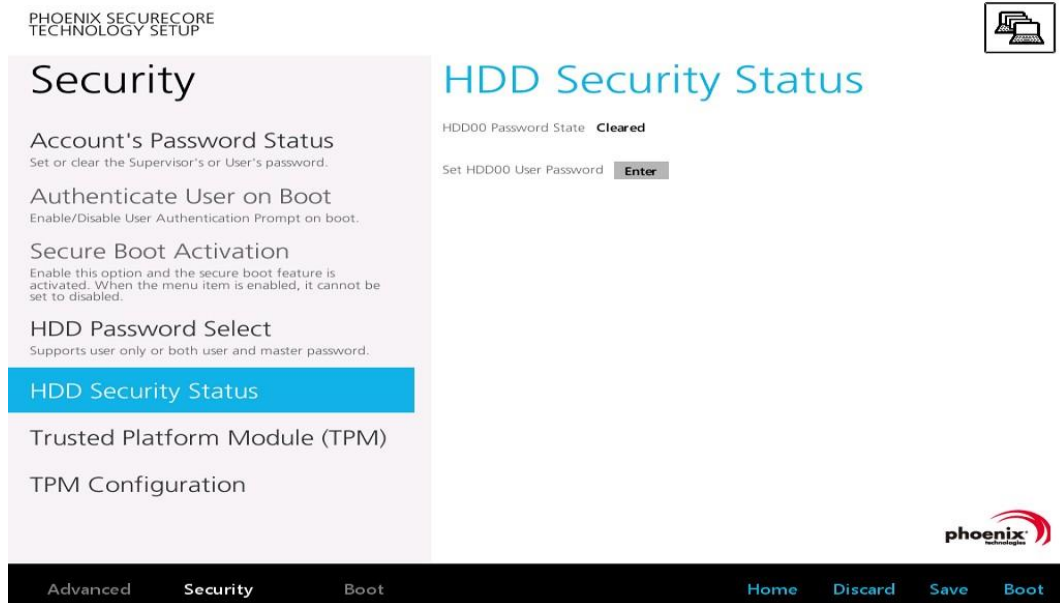

The screenshot displays the Phoenix SecureCore Technology Setup BIOS interface. The main title is "Security". The left sidebar contains the following menu items: "Account's Password Status", "Authenticate User on Boot", "Secure Boot Activation", "HDD Password Select", "HDD Security Status" (highlighted in blue), "Trusted Platform Module (TPM)", and "TPM Configuration". The main content area is titled "HDD Security Status" and shows the following information: "HDD00 Password State" is "Cleared", and "Set HDD00 User Password" has an "Enter" button. The Phoenix logo is visible in the bottom right corner. The bottom navigation bar includes "Advanced", "Security" (selected), "Boot", "Home", "Discard", "Save", and "Boot".

Chapter 9. Wi-Fi Hotspot Setup

VX-601 can be a gateway role for other devices to connect to the Internet. Windows has ways to create Wi-Fi hotspot, and the feature is integrated into “Network and Sharing Center”. Here is how to turn your Windows 7 into a Wi-Fi hotspot. (The process should be similar for Windows 8)

1. WWAN or LAN connection is properly connected to the Internet.
2. Make sure the Wi-Fi function is enabled (set WLAN to disabled by DashON), that isn't currently connected.
3. Go to the “Control Panel” and look for “Network and Sharing Center” and then go to “set up a new connection or network”

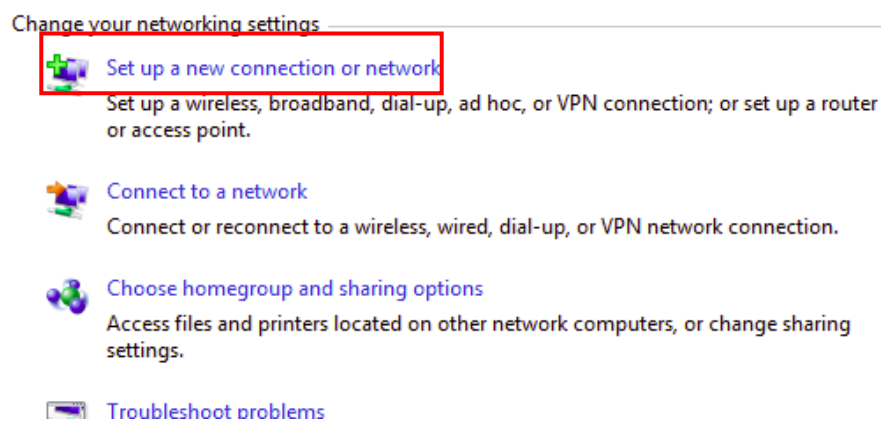

4. Select “Set up a wireless ad hoc (computer-to-computer) network” and click on “Next”

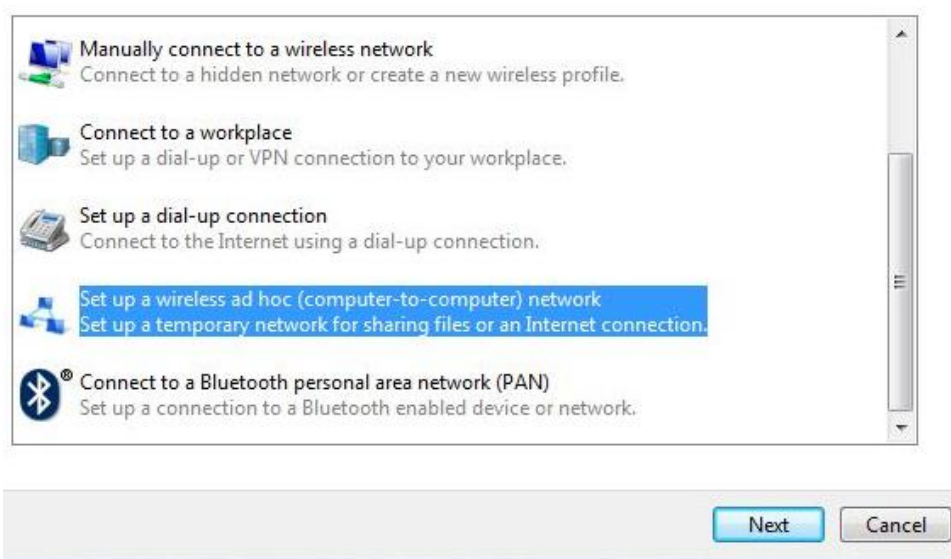

5. Click on "Next"

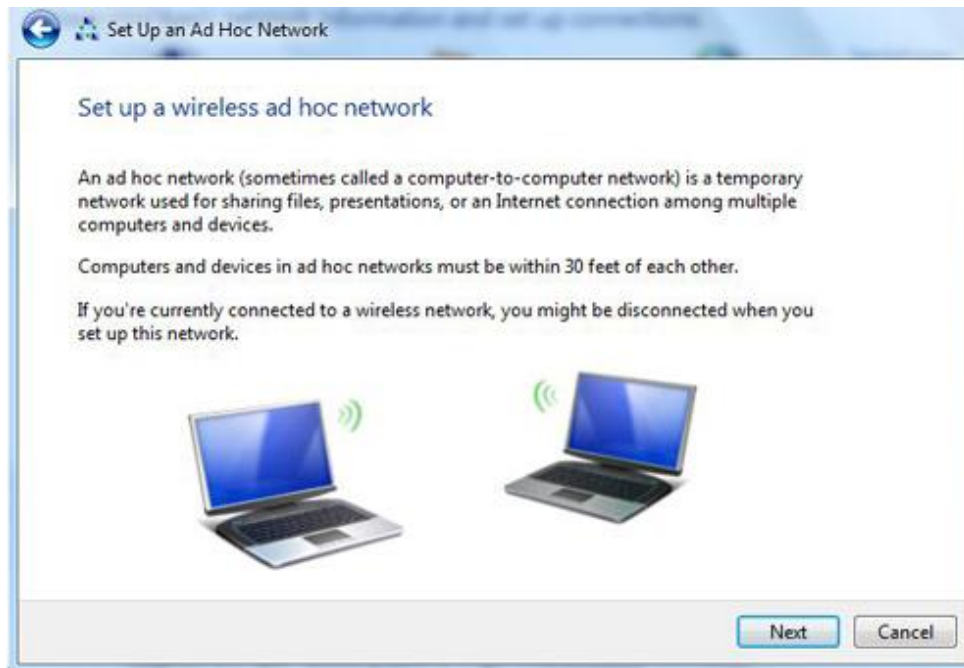

6. Enter the Network Name, choose a security type and enter the security key. Check the "Save this network" checkbox; it will save your network name on the Wireless network connection, and then click on "Next".



7. At this point your ad hoc network should be running and ready to start connecting your device. Click on the "Next".

Set Up an Ad Hoc Network

The BlogsDNA network is ready to use

This network will appear in the list of wireless networks and will stay active until everyone disconnects from it. Give the network name and security key (if any) to people you want to connect to this network.

Wireless network name:
Network security key:

To share files, open [Network and Sharing Center](#) in Control Panel and turn on file sharing.

Recommended options:

- Turn on Internet connection sharing

[Share an Internet connection on an ad hoc network](#)

Close